



April 15, 2016

Country Editor

Largest Circulation Publication in Herkimer County
Delivered Weekly by the U.S. Postal Service

Volume 5
Number 49

European Deli, NY Sun-Mon Closed
315-717-6638 f Tues-Fri 11a-6p
Europeandeliny.com Sat 11a-5p

EUROPEAN DELI
219 SOUTH MAIN ST, HERKIMER NY



Freeman's Drapery Shop
216 North Main St., Herkimer, NY
315-866-6000

25% Off with this ad
on Special Graber Blinds Promotion:
Blinds • Custom & Ready Made Drapes
Residential & Commercial
No charge for samples or measuring

Bruce Ward & Company
REAL ESTATE

Your 1st Choice
in the Mohawk Valley

315-866-2002

ASSOCIATE BROKERS

David Drapalski	868-3233
David Dudgeon	866-7578
Anna Duffy	717-3957
Lorraine Hartigan	868-1874
Michele Luke	868-0154
James Woodrick	542-2533

SALES AGENTS

Nancy Arno	895-4520	Pamela Radley	717-7530
Carol Collins	794-8894	Marie Scialdone	868-5563
Elyse Kane	868-3709	Carol Spisak	269-6933
Patricia Kelly	717-2421	Debbie Weston	985-0840
Jamie LaPorte	717-3994	Barbara Wiers	866-3356
Monica Munford	764-7618	Leslie Nicolette	985-0212

New To The Market!

219 N. PROSPECT STREET, HERKIMER, NY



\$105,000

44 South Third Ave., Ilion
Multi Family-1st fl Offers 1370 Sq. Ft. of Living w/Updated Kitchen, Island w/ Stove Top, 2 Br's, DR/LR Combo, Natural Woodwork w/New Laminating Flooring- 2nd fl Offers Large Kitchen w/Newly Remodeled Bath, Formal Dr & 2 Br's, Plenty to say & see- Let income pay your Mtg at \$105,000.



\$160,000

2649 St. Rt. 5, Schuylar
Classic Farm With Much Potential For Restoration- 3194 Sq. Ft., 5 Br's, 2 Baths, 1St Floor Laundry- Study/Den-Front Center Hall W/Stairway. Lot Includes 6 Parcels With Total Of 103.5 Acres A Lot For Your Money At \$160,000.



\$84,900

305 E. German St., Herkimer
Comfortable Family Home That Includes 3 Br's, Updated Kitchen, Lr-Fireplace, Inground Pool For Summer Fun, On 63X160 Lot A Steal for only \$84,900.



\$38,000

565 E. Jefferson St., Little Falls
3-4 Br's (1 Down) Eat-In Kitchen-Laundry On 1st Fl- Dining Rm Lr-Open Front Porch- 31X94 Lot- City Parking Across Street- Cheaper Than Renting Priced At \$38,000.



\$37,500

125 Loomis St., Little Falls
Buy And Make Your Own Or As An Investment Property Needs Some TLC But Newer Hwh & Roof-Workshop Built Right Off Spacious Kitchen- Only \$37,500



\$59,900

424 N. Bellinger Herkimer
Multi-Two Family- Offers 2 Br's, Each Apt, Proven Money Maker For The Investor- Also Could Be Comfortable Home For One Who Wants To Rent For Help w/Mtg Payment Selling for \$59,900.



\$79,900

819 1/2 Rose Place, Utica
Two Family Home On A Dead End Street-Close To Utica College-2 Bedrooms Each Apt- Bathrooms Have Recently Been Updated- New Hwh Too! Hdwd Floors- Separate Entrances- Asking \$79,900.



\$65,000

115 W. German St., Herkimer
Historic Cape Bearing Beams From Ft. Dayton Era- Could Make A Comfy Home- Simple Floor Plan, Hdwd Flooring, Knotty Pine Den w/Fp, Oversized Open Loft Att. Garage On 101X100 Lot Now Priced At \$65,000.



\$79,000

417 Henry St. Herkimer
Desirable Location Was Once An Office Bldg And An 3 Br Apt Up- Easily Converted To Apts Down-Separate Furnaces & Separate Electric- Make this your in home business at \$79,000.



\$84,900

187 Main Road, East Herkimer
This Three Family Building Has All Modern Apts- w/ Two-2 Br's, & One 1 Br Apts. Vinyl Sided, Plenty Of Parking & Convenient Location, Over 3,000 sq. ft. of living space- Buy it today \$84,900.



\$50,000

379 Otsego St., Ilion
Family Oriented 3 + Br /2 Additional On 3Rd Fl- Laundry On 1st Floor- Applianced Kitchen- Dr & Lr- Carriage House W/Garage & Loft Which Can Be Used As Craft Room- Convenient Location Near Village Parks- 40X150 Lot- Being Offered At \$50,000.



\$99,000

255 S. Third Ave., Ilion
Great Location Want To Downsize This Could Be It- 2 Br Cape Style 2 Baths, Applianced Kitchen, Dr & Lr- 1 Stall Att. Garage On 150X100 Lot Make Your Appt Today Now Priced To Sell At \$99,000.

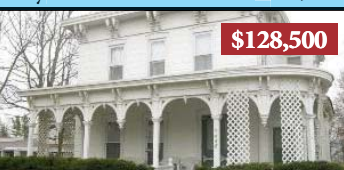

\$128,500

448 E. Main St., West Winfield
Victorian Home Loaded w/Character & Charm- Beautiful Wrap-around Front Porch, Double Door Entry to original Grand Staircase, 5 Br's, Formal Dr & Parlor w/Fireplace, Eat-In Kitchen- 2nd Fl provides access to the homes unique Capola. 2900 Sq. Ft. of living space on 1/2 Acre- Only \$128,500

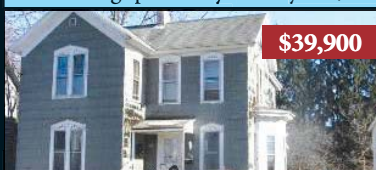

\$39,900

208 E. Smith St., Herkimer
Two Family W/All Spacious Apartments And Ample Parking- 3 & 2 Br's, It Has A High Operating Income & Reasonable Purchase Price \$39,900
Good Combo For The Wise Investor

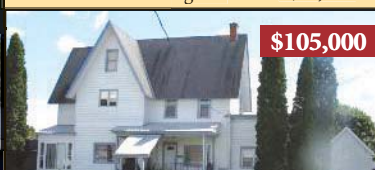

\$105,000

134 Second Ave., Herkimer
Three Family-Multi- Packed With Potential- Currently Used As Student Housing W/8 Br's, Grand Lr W/Ceramic Fireplace & Mahogany Beams, Redecorated Kitchen, Open Front Porch Now Priced To Sell At \$105,000.



\$74,900

531 Renwick Ave., Herkimer
Lovely Dutch Colonial-Move-In Condition- 2 Br's, Laundry On 1st Floor- Open Dr & Lr, Applianced Kitchen Hdwd Floors 1st Floor-Clean/Bright & Cheerful-Quiet Setting On A Dead End Street Selling now for only \$74,900.

PRSRT STD
U.S. POSTAGE
PAID
UTICA, NY
PERMIT NO. 55
ECRWSS

*****ECRWSSDDM****
Local Postal Customer

PRICE REDUCED

www.brucewardusa.com

to find these listings and more.

You Always Save at MAVIS DISCOUNT TIRE



BRAKE SPECIAL

\$129.99, Now ...

\$69⁹⁹

Save Big!

SUV's, Minivans, Pickups Add \$10
 • Includes Labor
 • Premium Brake Pads

LIFETIME WARRANTY ON PADS

Front or Rear pads or shoes. Not Combinable with other offers. Most cars. w/AD. Ends 5/17/16

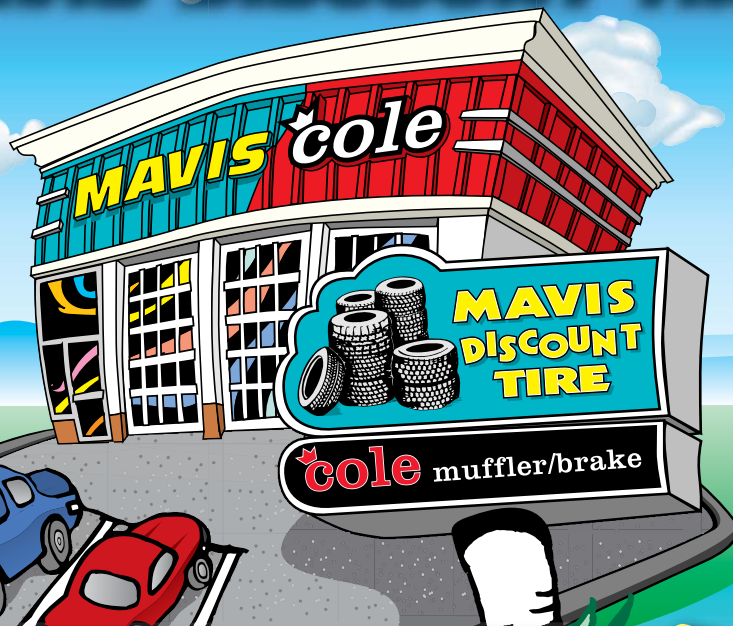

Buy 3 Get 1 FREE!

ENTRY SERIES TIRES **SAVE!**

PASSENGER PERFORMANCE

REG. PRICE \$106⁹⁹ (EA)
 AVG. PRICE AFTER FREE
\$80²⁴*

185/65-14 SK

SUV & LIGHT TRUCK DEALS

REG. PRICE \$131⁹⁹ (EA)
 AVG. PRICE AFTER FREE
\$98⁹⁹*

235/75-15 S

PASSENGER

\$46⁹⁹

175/65-14

PERFORMANCE

\$50⁹⁹

195/60-15

SUV & LT

\$75⁹⁹

235/75-15

Size	Brand	Reg. Price	Avg. Price After FREE
195/70-14	SK	\$106 ⁹⁹	\$80 ²⁴
215/70-15	SK	\$112 ⁹⁹	\$84 ⁷⁴
205/70-15	SK	\$119 ⁹⁹	\$89 ⁹⁹
205/65-15	SK	\$112 ⁹⁹	\$84 ⁷⁴
185/60-15	SK	\$112 ⁹⁹	\$84 ⁷⁴
205/60-16	SK	\$125 ⁹⁹	\$94 ⁴⁹
225/60-16	SK	\$125 ⁹⁹	\$94 ⁴⁹
205/55-16	SK	\$119 ⁹⁹	\$89 ⁹⁹

Size	Brand	Reg. Price	Avg. Price After FREE
235/75-15	S	\$131 ⁹⁹	\$98 ⁹⁹
245/75-16	S	\$152 ⁹⁹	\$114 ⁷⁴
235/70-16	SK	\$152 ⁹⁹	\$114 ⁷⁴
245/70-16	SK	\$152 ⁹⁹	\$114 ⁷⁴
265/70-16	S	\$172 ⁹⁹	\$129 ⁷⁴
265/70-17	S	\$185 ⁹⁹	\$139 ⁴⁹
LT225/75R16	S	\$159 ⁹⁹	\$119 ⁹⁹
LT265/75R16	S	\$189 ⁹⁹	\$142 ⁴⁹

175/70-13	\$64 ⁹⁹
185/70-14	\$52 ⁹⁹
195/70-14	\$50 ⁹⁹
205/70-15	\$60 ⁹⁹
185/65-15	\$53 ⁹⁹
195/65-15	\$51 ⁹⁹
205/65-16	\$67 ⁹⁹
215/65-16	\$61 ⁹⁹
225/65-16	\$77 ⁹⁹

215/60-16	\$62 ⁹⁹
215/55-16	\$62 ⁹⁹
215/55-17	\$71 ⁹⁹
225/55-17	\$71 ⁹⁹
205/50-17	\$65 ⁹⁹
215/50-17	\$72 ⁹⁹
225/50-17	\$71 ⁹⁹
215/45-17	\$60 ⁹⁹
225/45-17	\$64 ⁹⁹

215/70-16	\$76 ⁹⁹
225/70-16	\$75 ⁹⁹
235/70-16	\$85 ⁹⁹
225/65-17	\$83 ⁹⁹
235/65-17	\$84 ⁹⁹
245/65-17	\$109 ⁹⁹
235/60-17	\$84 ⁹⁹
235/60-18	\$93 ⁹⁹
235/55-18	\$114 ⁹⁹

S = Starfire Tires (Made by Cooper) K = Kelly Tires Edge A/S™ (Made by Goodyear)



MICHELIN

\$70 OFF+

after mail-in rebate **SAVE!**



GOODYEAR

\$70 OFF**

up to after mail-in rebate **SAVE!**



BRIDGESTONE

\$70 OFF+

after mail-in rebate **SAVE!**



HERKIMER
 101S. Main St
315-866-1557

Cobleskill OPEN LATE THURSDAYS!
 767 East Main St.
518-823-1293

New York Mills
 4863 Commercial Drive
315-294-7958

Oneida
 241 Genesee St.
315-363-5400

Rome
 1723 Black River Blvd
315-339-3460

Utica
 1728 Oriskany St.
315-733-6845

Utica
 2020 Genesee St.
315-724-4171

* To qualify for "Buy 3 get 1 Free" promotion, all 4 new tires must be balanced and the vehicle aligned. "Buy 3 Get 1 Free" is, buy 3 at regular price, get 1 free. All tires must be same size. Must buy (4) Four Tires to receive discounts. Offers are not to be combined with any other promotions or discounts. Excludes warranty tires and special orders. Ad must be presented at time of purchase. Valid on Starfire Tires or Kelly Tires Edge A/S™ only. Ends 5/17/16
 † by mail-in rebate when you purchase a set of four, select, Michelin tires. Must buy 4. Tires must be mounted and balanced at a store location. No carry outs. Not combinable with any other offers. See store associate for details. Valid 4-11-16 – 5-26-16
 ** by mail-in rebate when you purchase a set of four, select, Goodyear tires. Must buy 4. Not combinable w/any other offers. See store for details. Valid 3-1-16 – 6-30-16
 ‡ by mail-in rebate when you purchase a set of four, select, Bridgestone tires. Must buy 4. Not combinable w/any other offers. See store for details. Valid 4-1-16 – 4-30-16
 Actual tread design may vary from those shown. Some items/sizes by special order only. If we are out-of-stock on an advertised item, we will issue a rain check. Purchases may be limited to normal retail quantities. Not responsible for typographical errors. See stores for warranty info. PRICES VALID W/AD ONLY.

We Price Match!



MAVISTIRE.com

OPEN 7 DAYS! MON-FRI 8AM-6PM, SAT 8AM-5PM, SUNDAY 9AM-5PM

MUFFLERS & EXHAUST

\$25 OFF!

\$25 off exhaust purchases over \$125. Most cars. w/AD. Not combinable w/ any other offers. Ends 5/17/16

SHOCKS & STRUTS

25% OFF!

In-stock parts, Struts without electronic sensors. Not combinable w/ any other offers. Most cars. w/AD. Ends 5/17/16

TIRE ROTATION

FREE!

Most cars. w/AD. Not combinable w/ any other offers. Ends 5/17/16

WHEEL ALIGNMENT

\$10 OFF!

Computerized Wheel Alignments. Most cars. w/AD. Not combinable w/ any other offers. Ends 5/17/16

OPEN 7 DAYS A WEEK
Delivery ALL DAY!

Pizza Boys

New York Mills
315-520-7111
Little Falls
315-823-1860

Tuesday
\$1 Slices
All Day!

True New York Pizza

Personal 10" 6.99
6 Cut
Cheese or Garlic

Medium 14" 9.99
8 Cut
Cheese or Garlic

Large 16" 12.99
8 Cut
Cheese or Garlic

X-Large 18" 14.99
10 Cut
Cheese or Garlic

Toppings

Personal 1.25 Medium 1.75 Large 2.25 X-Large 2.75
Pepperoni • Mushrooms • Sausage • Green Peppers • Ham • Meatballs • Bacon • Grilled Chicken • Crispy Chicken • Anchovies • Spinach • Broccoli - Tomatoes • Black Olives • Onions • Banana Peppers • Pineapple

Specialty Pies

Personal 10" 9.99

Medium 14" 13.99

Large 16" 16.99

X-Large 18" 19.99

Buffalo Chicken
Buffalo Sauce, Grilled Chicken,
& Mozzarella Cheese

Popeye's Pie
Fresh Spinach, Tomatoes, Garlic,
Ricotta & Mozzarella Cheese

Hawaiian
Ham, Pineapple, Bacon &
Mozzarella Cheese

Gold Dust Chicken
Gold Dust Chicken &
Mozzarella Cheese

Carnivore
Pepperoni, Sausage, Meatballs,
Ham, Bacon & Mozzarella Cheese

Chicken Bacon Ranch
Grilled Chicken, Bacon, Ranch
& Mozzarella Cheese

E.B.A.
Pepperoni, Sausage, Mushroom,
Peppers, Onions & Mozzarella Cheese

Tree Hugger
Tomato, Onion, Broccoli, Garlic,
Ricotta, & Mozzarella Cheese

Mac Daddy
Secret Sauce, Ground Beef,
Tomato, Onion, Mozzarella
& American Cheese,
topped with Lettuce

Mac and Cheese
(May add bacon)
Cheddar Cheese Sauce, Pasta &
Mozzarella Cheese.
Topped with breadcrumbs!

Philly Steak
Mushrooms, Peppers,
Onions, White American &
Mozzarella Cheese

The Grandma
Fresh Mozzarella, Fresh Basil,
Fresh Garlic & Plum Tomato
One Size 19.99

**Sicilian
Upside Down**
(Toppings Extra)
One Size 16.99

Pizza & Wing Deals

Wings & Boneless Wings

Personal 10" Cheese Pizza & 1/2 Dozen 10.99
Medium 14" Cheese Pizza & 10 Wings 18.99
Medium 14" Cheese Pizza & 20 Wings 22.99
2 Medium 14" Cheese Pizzas & 30 Wings 36.99
Large 16" Cheese Pizza & 20 Wings 24.99
Large 16" Cheese Pizza & 30 Wings 31.99
2 Large 16" Cheese Pizzas & 50 Wings 49.99
X-Large 18" Cheese Pizza & 50 Wings 42.99

Traditional Buffalo Style
Mild • Medium • Hot • Inferno
10 Wings • 20 Wings 7.99 Per 10
30 Wings • 40 Wings
50 Wings • 60 Wings
11 Flavor Kings
Gold Dust • BBQ • Everything Buffalo Garlic
Buffalo BBQ • Honey Mustard • Sweet & Sour
Blue Hot • Garlic Parmesan • Sweet & Tangy
Honey BBQ

Toppings Extra - May Substitute Boneless Wings

1/2 Price
Boneless Wings
All Day Monday

• FULL MENU ONLINE •

Try Our New
BOOM BOOM
Sauce!

www.PizzaBoysNY.com

Large Pizzas
(Toppings Extra)
2 for \$22
Pizza Boys
315-823-1860
Cannot be combined with any other offer or deal. Expires 4-30-16.

Family Deal 1
XL Cheese Pizza (Toppings Extra)
20 Wings & 2 Liter
\$26.99
Pizza Boys
315-823-1860
Cannot be combined with any other offer or deal. Expires 4-30-16.

Family Deal 2
Lg. Cheese Pizza (Toppings Extra)
Lg. Order Baked Ziti, Texas Toast, Lg. Tossed Salad & 2 Liter
\$26.99
Pizza Boys
315-823-1860
Cannot be combined with any other offer or deal. Expires 4-30-16.

Any Large Sub
\$6.00
Pizza Boys
315-823-1860
Cannot be combined with any other offer or deal. Expires 4-30-16.

Medium 14" 2-Topping Pizza
\$9.99
Pizza Boys
315-823-1860
Cannot be combined with any other offer or deal. Expires 4-30-16.

The first tiny chick

by Katrina Weaver

It wasn't too long after our family moved to the country, that we decided to get a flock of chickens. We drove to the local farm store, where the shipment of chicks had just arrived. My siblings and I went over to look at the boxes of chicks. There were several different kinds of chicks there, as well as mallard ducklings. Being of a more practical mind, my mother and father picked several chicks of good laying kinds. My sister managed to catch two mallard ducklings, and my brother selected a fluffy chick with black dots on its head. However, I was looking intently at some ban-

tam chicks mixed in with the regular chicks.

"Daddy," I questioned. "Can I get a chick for my very own?"

"Of course!" replied my dad.

So I reached in slowly and scooped one up of the gray chicks. "Cheep! Cheep!" it shrilled loudly.

I cupped my hand over it gently, and tucked it carefully into the box with our other chicks. Soon thereafter, they were settled under a heat lamp and given chick food and water.

The chicks grew quickly and we soon moved them outside into a chicken tractor (a moveable chicken pen with no floor) where they enjoyed the luscious clover, fresh air, and space to run around. Soon the young chickens began to lay eggs, and my chick, whom I had

named, Little Chick, began to make some rather unexpected noises. It sounded kind of like a crowing cough—the sound that a young rooster makes before its voice is completely developed into a melodious crowing sound. What a surprise! Little Chick was a

THE FIRST 5



The author with her bantam rooster, Little Chick. Photo by Rose Weaver

Rhino Linings
THE SPRAYED-ON LINER™

\$50 OFF
Rhino Lining

Rhino Linings of Utica
912 South St.
315-732-8185

With Coupon - Expires 4/30/2016

Chuck Humphreville Paving

Blacktop • Driveways
Parking Lots

• THE COMPLETE JOB •

Over 40 Years In Business
Paving Specialist

Free Estimates • Written Guarantee
Call 894-4411 Anytime

MAPLE RIDGE BULK FOODS

~ Deli Specials ~

Eggs - \$1.50 Doz.			
Turkey Ham	\$3.87 lb.	Meunster Cheese	\$3.95 lb.
Honey Turkey Breast	\$5.50 lb.	Mozzarella Cheese	\$3.95 lb.
Roast Beef	\$5.99 lb.	Provolone Cheese	\$3.84 lb.
Sandwich Pepperoni	\$5.19 lb.	American Cheese	\$4.99 lb.
Buffalo Chicken	\$4.95 lb.	Pepperjack Cheese	\$3.99 lb.

Potatoes - \$14.50/bag, 10lb. Potatoes \$4.00

Mon-Sat 8am-5pm • Closed Sun • 315-219-1238
629 Mang Rd, Little Falls, NY 13365
Located off Rt. 29 in Salisbury Center. Take North Rd. to Mang Rd.

OPEN SUNDAYS

T & J

FRUITS / VEGETABLES
& GREENHOUSES

CELEBRATING 43 YEARS

We carry McCadam Cheese, Hapanowicz Meats, Queensboro tub butter and Farm Fresh Milk!
WE ACCEPT ALL MAJOR CREDIT CARDS & EBT CARDS

NOW IN

LARGE VARIETY OF CERTIFIED SEED POTATOES
STUTTARTER & RED ONION SETS

THIS WEEK'S SPECIALS

CALIFORNIA LETTUCE OR ROMAINE ~ 99¢/EA.
Red Seedless Grapes ~ \$1.99/LB.
RED OR SUNTAN PEPPERS ~ \$1.99/LB.
10LB BAG OF POTATOES ~ \$2.99
LOCAL MAPLE SYRUP, HONEY & SHARP CHEESE

~ Hapanowicz ~

- Kielbasa • Mushroom Stew • Chili
- Chicken Cacciatore • Chicken Soup
- Greens & Beans • Potato & Cheese Pierogies

221 S. Caroline St., Herkimer • (315) 866-7272
Serving You 7 Days A Week All Year Round
Open: 8am-6pm

DO YOU NEED TO SELL
ITEMS IN YOUR HOME OR ESTATE?

• Estate Liquidations • Downsizing Home
• Relocating Selling Items • Moving Sale

We handle the complete estate and moving sale of all home contents,
item appraisal and price tags.

Jeff Jones - Appraiser/Owner
mvescny@gmail.com

Cell 518-921-2992 Home 518-993-5333

mvescny@gmail.com
Jeffery Jones Sr.
Veteran Owned

81 Garfield St.
Fort Plain NY, 13339
C-518 921-2992 H-518 993-5333

Fratello's Pizzeria

201 E. Main St., Frankfort
315-894-8484
fratellospizzas.com

2 Large \$19.95!!

<p>Pizza Subs Wraps Wings</p>	<p>Panini Appetizers Haddock Riggies More!!</p>
--	--

With Coupon - Expires 4/30/2016

The Country Editor

Published weekly on Friday by Lee Publications
6113 St. Hwy. 5, Palatine Bridge, NY 13428

Publisher, President
Frederick W. Lee
V.P., General Manager
Bruce Button
V.P., Treasurer
Janet Lee Stanley

Controller.....Lyndsay Bock
Managing Editor.....Joan Kark-Wren
Production Coordinator.....Jessica Mackay
Shop Foreman.....Harry Delong

John Snyder, Sales Manager
518-673-0129, jsnyder@leepub.com
Tom Shaver, Sales Associate
315-985-5849, tshaver@leepub.com
Mary Skinner, Sales Associate
518-673-0130, mskinner@leepub.com
Fred Mang, Sales Associate
518-441-7299, fmang@leepub.com
Matt Stanley, Sales Associate
315-292-2306, matt.leepub@gmail.com
Kristen Lee, Sales Associate
518-673-0100, klee@leepub.com
Beth Snyder, Sales Associate
518-673-0101, bsnyder@leepub.com
Jed Suits, Sales Associate
518-673-0131, jsuits@leepub.com
Reader ads 518-673-3011 or 800-218-5586
Bruce Button-Corporate Sales Manager
518-673-3011, bbutton@leepub.com

Send all correspondence to:
PO Box 121, Palatine Bridge, NY 13428
Advertising e-mail: jsnyder@leepub.com
Editorial e-mail: jkarkwren@leepub.com
Subscriptions e-mail: subscriptions@leepub.com
Website: www.countryeditor.net
518-673-3011 Phone • 518-673-2381 Fax

We cannot GUARANTEE the return of photographs. Publisher is not responsible for typographical errors. Size, style of type and locations of advertisements are left to the discretion of the publisher. The opinions expressed in this publication are not necessarily those of the publisher. We will not knowingly accept or publish advertising which is fraudulent or misleading in nature. The publisher reserves the sole right to edit, revise or reject any and all advertising with or without cause being assigned which in his judgement is unwholesome or contrary to the interest of this publication. We assume no financial responsibility for typographical errors in advertisement, but if at fault, will reprint that portion of the ad in which the error appears.

THE FIRST from 4

rooster! I was quite thrilled to have a bantam rooster for my pet.

Over the course of several years, various other chickens were added to our farm. A few died of natural causes; others became tasty dinners. But many of them became special pets, chief among these being my special

never-to-be-sold-or-butchered rooster Little Chick. He was my beloved pet, and I am confident that he loves me duly in return. But he was not so friendly to other members of the family. Sometimes he would fly at them in a flurry of feathers, his spurs out and beak ready. They soon learned to steer clear of him. My grandmother, while

standing at a distance averred that he was "quite a character," chuckling good-naturedly.

Even though Little Chick was small, he was a natural protector of his hens. Once, our little black kitten tried to pounce on one of Little Chick's hens, but to Kitty's surprise, a furious little rooster descended upon her, spurs and beak

flying. You can be sure she got out of there as fast as her shocked paws would carry her, ready to return to a cat's proper job of stalking mice.

Little Chick also shared delicious bits of food with his hens that he found while grazing. A worm, or a stalk of wheat was a wonderful treat. He would give a high shrill noise, to which the hens

would come running, and gobble up the food, which he patiently kept for them until they came.

My chicken flocks have increased. Now I have new favorites among them. But none will ever take the place of Little Chick. For me, it all started with that one, tiny, cheeping ball of fluff, and then grew into more chickens, more eggs and

more pets to love and take care of. Chickens make wonderful pets as well as laying fresh, healthy eggs. I would highly encourage you to get some for your own backyard. They are something that is very rewarding to raise.

Who knows? If you give chicken raising a chance, your heart may be unexpectedly stolen away by some "Little Chick."

"Let us put one in your yard"

SOLD 315-429-9404

315-717-7269

EMPIRE HOMES AND COMMERCIAL

KOVAL'S

• **MAJOR APPLIANCE REPAIR** •
 Refrigerator • Stoves • Dishwashers • Cooktops
 • Washers • Dryers

Senior Discount • Same Day Service

Owner - Ed Kovalsky

30 Years Experience

315.867.9333

Ferdu's Landscape Supply

Wholesale & Hardscape Distributor

• Retaining Walls • Patio's • Walkways • Out Door Fireplace

315.894.4143

www.ferdulandscape.com

430 Railroad St., Frankfort

2 BEDROOM APARTMENTS

\$550/Month Utilities Included

North Main St., Herkimer
 (across from the library)

(315) 866-2475

Colleen's Creations
 in Landscaping & Lawn Care

- Lawn Mowing
- Shrub Trimming & Planting
- Spring & Fall Cleanups • Fertilization
- Retaining Walls & Walkways • Snowplowing
- And Much More

Commercial • Residential • Free Estimates

315-360-1824

Ziebart Of Utica

912 SOUTH ST. 315-732-8185

\$50 off Full Detail Pkg. Reg. \$149.99

Rhino Linings
 Sprayed on truck bedliner
 Rust Proofing Undercoating • Detailing

315-732-8185

Wash, wax, windows, tires, rims, vacuum, shampoo, motor, complete interior etc.

Central Watch & Clock Repair

Buying Costume Jewelry, Watches, Clocks, Parts & Tools
 Any Condition - One Piece or Collections

BUYING GOLD, SILVER & JEWELRY

Mike Walz, Sr.
315-868-4266

243 Mohawk Street
 Herkimer, NY 13350

Men's Golf Clinic
 6 Sessions Only \$99
 Begins May 2nd

GOLF LESSONS
 By Mark Lane
 Head PGA Professional
 at Mohawk Valley Country Club

518-844-4558

"I keep the rust off your swing"

Netti Powersport
 Suspension Services

Motorcycle - ATV - Snowmobile

315-868-3099

Division of Krenichyns Plumbing and Heating

2010 GMC Terrain AWD

Very nice inside and out. High miles, but excellent care. All service records available. Priced well below book at \$8,775. It is on the road and driven daily. Just passed NYS inspection. New tires and brakes.

Call/Text Dale at 518 495-2384

AVICO BRAND

BROAD STREET CASH & CARRY
 Celebrating 34 Years 1982-2016!

729 BROAD ST. UTICA, N.Y. 13501
(315) 724-8249

SERVING: Grocers, Restaurants, Pizzerias, Delis, Bakers & Institutions
HOURS: Monday-Friday 8-5pm, Saturday 9-2pm, Closed Sundays

Home of the "Utica Grind" Hoodies, Aprons & Mugs Now Available!

SPECIAL CLOSEOUT PRICES

UTICA'S ORIGINAL CASH & CARRY
 OVER 30 YEARS!!

HOME OF THE UTICA GRIND

WHOLESALE FOOD & PAPER OUTLET

OPEN TO THE PUBLIC
 724-8249 • WWW.AVICOSPICE.COM

FRANKFORT VALLEY AUTO SALES

WE SELL QUALITY PRE-OWNED VEHICLES!

- ✓ **BAD CREDIT?**
- ✓ **NEED A CAR**
- ✓ **ASK ABOUT OUR GUARANTEED CREDIT APPROVAL**

Fully Staffed Service Dept. & Body Shop
 Come and See us for All Your Automotive Needs

Serving the Mohawk Valley For 38 Years!

(315) 895-7402 • E. Main St., Frankfort, NY
 View a Complete listing of our inventory at www.FVAS.us

How can I protect against ticks and prevent Lyme disease?

Deer ticks live in shady, moist areas at ground level. They will cling to tall grass, brush and shrubs, usually no more than 18-24 inches off the ground. They also live in lawns and gardens, especially at the edges of woods and around old stonewalls. Deer ticks cannot jump or fly, and do not drop onto passing people or animals. They get on humans and animals only by direct contact. Once a tick gets on the skin, it generally climbs upward until it reaches a protected area. In tick-infested areas,

your best protection is to avoid contact with soil, leaf litter, and vegetation. However, if you garden, hike, camp, hunt, work, or otherwise spend time in the outdoors, you can still protect yourself:

- Wear light-colored clothing with a tight weave to spot ticks easily.
- Wear enclosed shoes, long pants and a long-sleeved shirt. Tuck pant legs into socks or boots and shirt into pants.
- Check clothes and any exposed skin frequently for ticks while outdoors.
- Consider using insect

repellent.

- Stay on cleared, well-traveled trails. Walk in the center of trails. Avoid dense woods and bushy areas.
- Avoid sitting directly on the ground or on stonewalls.
- Keep long hair tied back, especially when gardening.
- Bathe or shower as soon as possible after going indoors (preferably within two hours) to wash off and more easily find ticks that may be on you.
- Do a final, full-body tick check at the end of

the day (also check children and pets), and remove ticks promptly.

What are the symptoms of Lyme disease?

The early symptoms of Lyme disease may be mild and easily missed. If you find a tick attached to your skin, remove the tick with tweezers, and watch for the symptoms of Lyme disease. In 60-80 percent of cases the first symptom is a rash, known as erythema migrans, that:

- Occurs at or near the site of the tick bite.
- Is a "bull's-eye" circu-

lar patch or solid red patch that grows larger.

- Appears between three days and one month after the tick bite.
- Has a diameter of two

to six inches.

- Lasts for about three to five weeks.
- May or may not be

How 7

SPRING SPECIAL

CHARLES D. STAHL
SPLIT HARDWOOD
"SPECIAL TRUCKLOAD SALES"

5+ Face Cords Delivered **\$375**
Approx. 7 1/2 Face Cords **\$495**
Approx. 11+ Face Cords **\$775**

FURNACE CHUNK WOOD
Approx 11+ Face Cords **\$695**
Delivered (may include extra delivery charges)

HEAP ACCEPTED

697 Snells Bush Rd.,
Little Falls, NY 13365
315-823-1982



Curious About Your Water Quality? Call the Expert!!!

COUNTRYMAN WATER CONDITIONING

SALES • SERVICE • RENTALS

- A Family Business Since 1956 •

Certified Water Specialist
6880 State Hwy. 5S
Fort Plain
countrymanwater@yahoo.com

FREE WATER ANALYSIS

518-993-2888 • 1-800-993-2824



Home Land & Site Clearing
Serving Herkimer & Otsego Counties
FULLY INSURED

Ron's Tree Removal
Mohawk, New York 13407

25 Years Experience
Clipping • Trimming • Stumping • Saw Milling • Clean Ups & Firewood
Senior Citizen Discounts

10% Off Any Job with this Coupon Offer Expires 5/31/16

315-866-3889 FREE ESTIMATES



MAB Air Solutions, LLC

985-9229
336 E. State St., Herkimer

WIN A FREE CLEAN AIR MACHINE

Revitalizes • Humidify • Sanitizes • Medicate • Vaporizes
Disinfect • Aromatizes • Night Light • Deodorizes • Clean, Fresh Air

Cleans 300 sq. ft. per hour



COLLINS REPAIR SERVICE

Collision, Brakes & Auto Body

INSURANCE CLAIMS WELCOME

Over 30 Years Experience
RUSSELL COLLINS, OWNER

2923 State Route 168, Mohawk
(315) 866-7040 • collinsrepair58@gmail.com

Your Choice Your Vehicle



Commercials - Editing - Live Production

New Service: Local VHS to DVD Transfers

Let us transfer your VHS tapes to DVD or Digital Files

Call Today **797-3944**

100 Oriskany Blvd.
(Next to Holland Farms)

TV Video Productions Est. 1983



Need Therapy? Try Russo

Russo Physical Therapy

895-0012
4266 Acme Rd., Frankfort

"THERAPY SERVICES FOR ALL AGES"

Robert S. Russo Jr., MS, MSPT

Visit & Share on Facebook



Whatchamacallits

Continuing with our cooperage theme, this week we have a grouping of three unusual tools created specifically for the barrel maker. This particular group was manufactured in the 19th century and are: a barrel croze plane (top); a leveler plane (left) and a howell plane(right). The croze is the groove that runs around the inside of the top and bottom of the cask which held the head in place and is cut using the croze plane or cooper's router. As you can imagine using this tool requires a lot of strength. The cooper has to cut the groove straight and at a uniform depth while working on a slope inside a circular container. The leveler plane was used for leveling the ends of the oak staves — the slats that make up the barrel sides — once they were held together with the hoop. Our last tool, the howell plane was actually used before the croze plane to make a howell (or lip, if you will) around the inside of the barrel. The croze is made afterward in order to hold the head (barrel end). There is a fascinating video on YouTube called **Making barrels for Guinness in old times** that shows similar tools (and more) in actual service

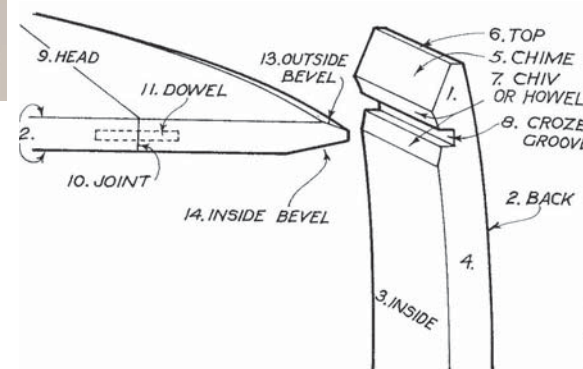

Do you have your own Whatchamacallit?

Send a photo and short description to csuo@leepub.com or call Colleen at 518-673-0145

How from 6

warm to the touch.

- Is usually not painful

or itchy.

- Sometimes leads to multiple rashes.

Ticks will attach themselves anywhere including the thighs, groin, trunk, armpits and behind the ears. If you are infected, the rash may be found in one of these areas.

How can I safely remove a tick?

If you DO find a tick attached to your skin, do not panic. Not all ticks are infected, and your risk of Lyme disease is greatly reduced if the tick is removed within the

first 36 hours. To remove a tick:

- Use a pair of pointed tweezers to grasp the tick by the head or mouthparts right where they enter the skin. DO NOT grasp the tick by the body.
- Pull firmly and steadily outward. DO NOT jerk or twist the tick.
- Place the tick in a small container of rubbing alcohol to kill it.
- Clean the bite wound with rubbing alcohol or

hydrogen peroxide.

- Monitor the site of the bite for the next 30 days for the appearance of a rash.

If you develop a rash or flu-like symptoms, contact your health care provider immediately. Although not routinely recommended, taking antibiotics within three days after a tick bite may be beneficial for some persons. This would apply to deer tick bites that occurred in areas where

Lyme disease is common and there is evidence that the tick fed for more than one day. In cases like this you should discuss the possibilities with your doctor or health care provider.

In 2015, there were 38 confirmed cases of Lyme disease in Herkimer County. For additional information, or if you have any questions, call Herkimer County Public Health at 315-867-1176.

The Hair Affair



Michaline Kraszew

Natural Coloring Available
* Grape Seed Oil & Natural Ecotin
Hair Color also Color in Ten Minutes.
Color 10

232 Mohawk St.
Herkimer, NY 13350

315-867-4284

New Year... New Deals



THE BEST FOR LESS...
HASSLE FREE!



JESSE LICARI

 <p>2015 SUBARU WRX STI CPO \$2,00 below NADA book 1 Owner * Navigation * 26k * Premium Sound \$34,475</p>	 <p>2012 DODGE CHARGER R/T Red Leather Interior * Heated Seats * Navigation * 45k \$22,995</p>	 <p>2011 DODGE AVENGER LUX Leather * Sunroof * Touch Screen \$12,995</p>	 <p>2011 DODGE GRAND CARAVAN SXT 29K * DVD Player * Stow-N-Go * Navigation \$22,595</p>
 <p>2014 DODGE JOURNEY SXT CPO \$2,000 below NADA Book Value * 45k * Third Row * AWD \$19,495</p>	 <p>2008 CHEVROLET TAHOE LT LT Pkg * Third Row * 4WD * Sunroof \$18,995</p>	 <p>2011 FORD F150 SXT 4WD * 31k * V8! 5.0L * Lots of Xtras! \$23,995</p>	 <p>2012 DODGE RAM 1500 ST 4WD * 54k * Front Line Ready \$23,795</p>

ROUGH COUNTRY

SUSPENSION SYSTEMS

CNY's Authorized Dealer



EVERYONE'S APPROVED!

EVERY CAR WE SELL

GWC WARRANTY CERTIFIED

PRE-OWNED VEHICLES

DAY ONE/MILE ONE COVERAGE

LICARIMOTORCAR.COM | 315.866.4141

Small Engine Repair



DON'T WAIT TO SERVICE YOUR POWER EQUIPMENT!

We can get you up & running for all your summer projects

Briggs & Stratton Certified Mechanic

COLLIS HARDWARE

True Value
START RIGHT. START HERE.™

Just Ask
RENTAL

Buy What You Want.
Rent What You Need.®

104 N. Main St., Herkimer, NY • 866-0826
WWW.TRUSITE.COM/COLLIS • Mon.-Fri. 7:30am-6pm; Sat. 7:30am-5pm; Sun. 9am-3pm

Tattoos
Body Piercings

Ruthless

Juk

NYS Board of Health & OSHA Certified

10% OFF ANY TATTOO

With This Coupon • Offer expires 5/31/16

315-867-4396

16 W. Main St., Mohawk

facebook

Belfield Insurance Agency

Committed to Service

Contact us for all you insurance needs

315-985-9066



16 W. Main St., Mohawk
Melissareed06@frontier.com

Waterville & Mohawk Locations

Nature Works Landscaping



Patios, Fences, Shrubs & Hedge Trimming
Flower beds & more

You name it we do it!

12 years experience

Free estimates • Fully insured

315-868-4304

Paw's Corner

by Sam Mazzotta
Gifts That Aren't Appreciated

Dear Paw's Corner: My mother has a 3-year-old mixed Shi-tzu/poodle. He is very spoiled and loves to go with her everywhere. The problem is that when she leaves him (it doesn't matter what house he's left at), he leaves a large, smelly "present." I can see this is in defiance, but what can we do? Please reply; I'm desperate. -- C.L. via email

Dear C.L.: Your first move should be to erase the word "defiance" from your vocabulary. Yes, your mother's dog (let's call him "Fluffy") is getting upset when he's left behind, but he's not being angry or defiant or petulant. The term here is "separation anxiety," and many pets suffer from it.

Fluffy is very attached to your mother. And your mom keeps the dog close by at all times, bringing him along on most of her errands, as well as to your house, where she occasionally leaves him while she runs out.

The length of time she is gone doesn't matter. When your mother leaves Fluffy behind, he becomes very anxious. Like many anxious pets, he engages in destructive behavior -- in this case, soiling. Some pets chew up their owners' shoes or destroy the living room. Yelling at Fluffy, rubbing his nose in his own mess or confining him will not stop the behavior. His anxiety has to be addressed.

Fluffy needs independ-

ence training, possibly combined with an anti-anxiety drug. The veterinarian is the first step in the process. An obedience trainer can put together a regimen that gradually increases Fluffy's ability to be left alone.

If your mother follows the vet's (or trainer's) program faithfully, Fluffy will improve immensely. And your carpet will look much, much better.

(c) 2016 King Features Synd., Inc.



It's spring fever. That is what the name of it is. And when you've got it, you want — oh, you don't quite know what it is you do want, but it just fairly makes your heart ache, you want it so!
- Mark Twain

Heidelberg BREAD & CAFE
3056 State Rt. 28, Herkimer, NY
Ph: 315-866-0999

Cafe/Store Hours
Mon.-Sat. 7:00AM-6:00PM
Sundays 7:00AM - 5:00PM

OUR NEW LOCATION!!
JR's Auction
7403 St Hwy 5 • St. Johnsville, NY 13452 • (518) 993-4668
(Formerly Springers)

SELL IT! **The Auction Way!**

ANTIQUÉ CONSIGNMENT AUCTION Every Tuesday at 5:00pm
ATTENTION we have found a new supplier for Lumber and Building Materials!! Stop in every Tuesday night to see what we have for over Auction!!! Already consigned is 1-nice Maple China Cabinet, Maple Bookcase, 1-Metal 4 door locker, 2- nice wood shop shelf nits, 4-antique tool cabinets and much more!! Your Consignments Wanted!!

Sportsman and Tool Consignment Auction
WEDNESDAY APRIL 13TH 6:00PM
We are looking for nice Taxidermy and Ammunition Consignments for this Auction!! also Black Powder Rifles, Sporting Goods, New Tools, Used Tools, Tack, Lead Ropes, Snaps, and more!! will also take consignments for boats, canoes, campers, 4 wheelers, trailers & more. No Guns that require a back ground check!!
We are now getting our own FFL License should be ready for this fall will still be having our regular Sporting Auction with ammunition and tools. Don't Miss it!!

St Johnsville Fire Company Benefit Auction
SATURDAY APRIL 16TH 10:00AM
Donations Wanted; proceeds will raise money for the Fireworks and expenses for the Fire Company!! Help Us Raise Money!! Support The Community!! Donations Wanted of: Antiques, Furniture, Household, Tools, Equipment, Outside Items, New Tools, Machinery and more.

4th Annual Spring Consignment Auction
SATURDAY APRIL 23RD 9:00AM 3 AUCTIONEERS WILL BE SELLING!!
Farm Machinery, Equipment, Tools, Antique Buggies, Antique Machinery, Sleighs, Small Animals, Flowers, Trees, Shrubs, Furniture, and much more!!
Inside Main Hall: Furniture, and Antiques! Under Tent: New Tools and Tack!!
Pole Barn: Small Animals! Outside in Lean-to: Trees, Shrubs, Flowers!!
ALREADY CONSIGNED; 1-CIDER PRESS WITH GRINDER, 1-1933 CLECTRAC MINI DOZER W/BLADE (WORKS)
2 SLEIGHS, 2 BUGGIES, 1- RARE ANTIQUE WICKER PONY CART, 1-BUCKBOARD WAGON,
3-ANTIQUÉ FANNING MILLS, 2-WALK BEHIND PLOWS, 1-3 POINT FERTILIZER SPREADER,
1-275 GALLON FUEL TANK, 2 WORK HORSE HARNESSSES, A LARGE LOAD OF TREES, SHRUBS, AND PERENNIALS FROM LANCASTER COUNTY!! AND
MORE STILL COMING!! THIS IS THE THE AUCTION TO TURN YOUR ITEMS INTO CASH!!
We are taking consignments for this Auction including: Farm Machinery, Equipment, Tractors, Bull Dozers, Lawn Tractors, Hay Equipment, Trailers, Boats, Canoes, Outdoor Sporting Equipment, 4 Wheeler's, Lawn and Garden Equipment!! Inside Consignments we need Complete Estates, Antiques, Furniture, Paintings, Collectibles, New and Used Furniture!! We are also receiving consignments for Flowers, Trees, Shrubs, and Garden Related Items!! Chicken BBQ, Subs, Ice Cream, and lots of good homemade food!!!!

WEEKLY SALES EVERY MONDAY HOSKING SALES

Weekly Sales Every Monday 11:30 AM with Misc. & Small Animals, 1:00 PM Dairy, followed by feeders, sheep, lamb, goats, pigs. Calves start at 5:00 PM followed by cull beef. Call for more info and note all times are approximate. Our volume is increasing weekly - join your neighbors & send your livestock our way!

*****ATTENTION ORGANIC PRODUCERS - WE ARE NOW A CERTIFIED ORGANIC MARKETING AGENCY.*** IF YOU HAVE ANY QUESTIONS PLEASE CONTACT US.**

Monday, April 4th - Sold 180 Head. Cull ave. \$.68 Top Cow \$.95, Bulls/Steers \$.88, Bull calves top \$3.35, heifer calves top \$3.45, Dairy feeders \$.92 - \$.96, Feeder bulls \$1.00, Feeder Heifers \$1.21 - \$1.23, Goats up to \$235, Kid goats up to \$90.

Mon. April 18th - Normal Monday - This will be our Spring Fat Cow & Feeder Turnout Sale. Special group of 400# - 500# Angus feeders. A group of Hereford yrlg. Feeders; a load of Angus cross feeders. A lot of calls we expect a good run. We will start excepting cattle on the week-end 4/16 & 4/17. (note we will be doing this during our regular Monday sale) Call to advertise your group

Sat. April 23rd - Annual Spring Machinery & Equipment Auction & we will be selling Plants, Trees, Shrubs, flowers and a load of small hand tools. We will start at 9:30 AM on small and be on large equipment by Noon. The field is filling up a few consignments of: Val-Metal V-Mix 400 w/8' elevator, NH 1410 Discbine (excellent); JD 335 Round Baler, Hayrite transport elevator, NH 256 Rake w/dolley wheel, 16' hay wagon, Ezee trail kicker wagon, 8 1/2x18 Stoltzfus Steel Kicker wagon, 8+2 Stoltzfus Round Bale Wagon, 16' Stoltzfus Feeder wagon w/headlocks, farm dump truck, 3 pt ditch bank mower, NH 310 kicker baler, Onan Diesel Generator 6KW, Ford 1700 Tractor w/snowplow, Farmall A WFE, Bush hog, 2009 16' Corn Pro bumper pull cattle trailer, Kuhn 1219 Manure Spreader, 1209 Haybine, Nickelson Tedder, Ground driven manure spreader. Call to advertise your equipment.

Monday, April 25th - Normal Monday Sale & Monthly Organic Day
Monday, May 2nd - Normal Monday Sale & Monthly Fat Cow & Feeder Sale.

Sat. May 7th - 11:30 AM Georgetown, NY. Many Maples Retirement Registered Brown Swiss Dispersal

Mark your calendars! For these sales:
Sat. Sept. 10th - 10:30AM Homer, NY. Westan Farm Registered Holstein Dispersal. 250 Head of NYS Finest!! Owners: Dan & Bud Weddle.
Sat. Nov. 5th - 11:30AM Fall Premier All-Breed Sale
Sat. March 25th - 2017 Spring Premier All-Breed Sale
LOOKING TO HAVE A FARM SALE OR JUST SELL A FEW - GIVE US A CALL.

****Trucking Assistance - Call the Sale Barn or check out our trucker list on our Website. Call to advertise in any of these sales, it makes a difference. Watch website for any last minute updates.**
Directions: Hosking Sales, 6096 NYS Rt. 8, 30 miles South of Utica & 6 miles North of New Berlin, NY.
www.hoskingsales.com Call today with your consignments.
Like us on Facebook

Tom & Brenda Hosking & Family
6096 St. Hwy. 8, New Berlin, NY 13411
cell: 607-972-1770 or 1771

HOSKING SALES 607-847-6274 or 607-847-8800

CNY Seamless Gutters
315-877-7091
Facebook.com/CNYseamlessGutters

- Gutter Installation
- Gutter Repair, Resealing
- Power Washing
- Plumbing & Electrical Repair

\$75 OFF Any Whole Home Installation (gutters only)

\$25 OFF Any Partial Installation (gutters only)

Free At-Home Estimates

Full Throttle LLC
6 South Division Street, Saint Johnsville, NY 13452
518-568-8113

****Want to sell your machine? Call us first!!! Cash on the spot!!!****

We buy, sell and trade ATV's, snowmobiles, and motorcycles

- Many used snowmobiles and ATV's for sale meeting all price ranges!!!!
- Refurbish four wheeler and snowmobile seats
- Moose Plows sales and installation
- All oils and snowmobile accessories
- ATV tire sales and installation
- Snowmobile tracks and installation
- Helmets and Goggles
- We fix Snow blowers, weed eaters, lawn mowers, ALL SMALL ENGINES
- Most parts and accessories come next day

****WE WILL PICK UP AND DELIVER ALL MACHINES!!!!****

Waterfront Grille
800 Mohawk St., Herkimer, NY
315-717-0700

10% OFF your check for lunch or dinner
not valid with any other offer
expires 5-31-16

THE PLACE IS *HERE*. THE TIME IS *NOW*. THE SAVINGS ARE *HUGE!*



2015 CHRYSLER 200 LIMITED

STK# R5652 • 32,773 MILES • PRIOR RENTAL

\$15,000
PLUS TAX, TAGS & DMV FEES



2014 JEEP PATRIOT SPORT 4X4

STK# R5583 • 26,799 MILES • PRIOR RENTAL

\$17,000
PLUS TAX, TAGS & DMV FEES



2014 JEEP COMPASS SPORT 4X4

STK# R5330 • 16,381 MILES • PRIOR RENTAL

\$18,000
PLUS TAX, TAGS & DMV FEES



2014 DODGE GRAND CARAVAN SXT

STK# R5417 • 35,425 MILES • PRIOR RENTAL

\$18,000
PLUS TAX, TAGS & DMV FEES



2014 DODGE CHARGER SE

STK# R5261 • 17,333 MILES • PRIOR RENTAL

\$19,000
PLUS TAX, TAGS & DMV FEES



2014 CHRYSLER TOWN AND COUNTRY TOURING

STK# R4718 • 30,841 MILES • PRIOR RENTAL

\$20,000
PLUS TAX, TAGS & DMV FEES



2015 JEEP GRAND CHEROKEE LIMITED 4X4

STK# P5681 • 54,352 MILES

\$27,000
PLUS TAX, TAGS & DMV FEES



2015 JEEP CHEROKEE TRAILHAWK 4X4

STK# P5561 • 9,544 MILES

\$29,000
PLUS TAX, TAGS & DMV FEES



NEED FINANCING? BILLY MAY BE ABLE TO HELP. APPLY FOR PRE-APPROVAL AT: GETHUGEcredit.com



FUCCILLO CHRYSLER, DODGE, JEEP, RAM OF NELLISTON

6460 STATE HIGHWAY 5 • NELLISTON, NY • 518-993-5555 • HUGEPLEX.COM

HOURS: SALES MON.-THURS. 9-7, FRI.-SAT. 8-6, SUN. 10-5 SERVICE MON.-FRI. 9-5

PRIOR SALES EXCLUDED. SEE DEALER FOR COMPLETE DETAILS. PRICING AVAILABLE FROM APRIL 1, 2016 THROUGH APRIL 30, 2016.



Spring in Little Falls



Little Falls Carpet's **SPRING FLOORING SALE**

FREE IN HOME ESTIMATES | **ALL IN STOCK REMNANTS CARPET • VINYL/LINOLEUM**

20% OFF

CARPET • PAD • INSTALLATION

\$2³² Reg. \$3.19
Sq. Ft. Sq. Ft.

Free In Home Estimates

LITTLE FALLS CARPET
556 East Main Street, Little Falls **315-823-3200**
Hrs: Monday-Friday 9-5, Saturday 9-1, Closed Sunday
We Make Nice Things Happen!
www.littlefallscarpet.com

BODY SIENSE
MAKING SENSE OF BODY SCIENCE

Body Siense Massage Care Center

Couples, Sports, Medical Massage, Adolescent, Predesigned Massage Packages to Suit Every Wellness Need!

Visit Our New Website bodysience.com

410 Canal Place, Suite 207
Little Falls, NY 13365
(315) 985-8556

BODY SIENSE

POHLIG ENTERPRISES INC.
LOVENHEIM'S
634-636 E. MAIN ST., LITTLE FALLS • (315) 823-2640
"Over 50 Years Combined Experience in the Decorating Business!"

Arborcoat, Ext. Line, Ext. Stain Benjamin Moore Paints & Primers

- Wallcoverings (in stock and custom orders)
- Window Treatments • Mattresses • Sundries
- Floor Coverings - Carpet, Sheet Vinyl, Cork Floors & More

Benjamin Moore Paints | Armstrong | Kirsch |

"Customer Service is Our Priority!"
All Major Credit Cards Accepted
Hrs: Mon., Tues., Wed., Fri. 8-5; Thurs. 8-6; Sat. 9-3; Sun. Closed

DRIVEN TO DO MORE

CHALLENGER 500 SALE PRICE \$8,499*

CHALLENGER 700 SALE PRICE \$9,499*

LOADED STANDARD EQUIPMENT PACKAGE | **STRENGTH TO RIDE HARDER, LONGER** | **POLISHED ALLOY WHEELS AND HEAVY-DUTY BEARINGS**

EXCEPTIONAL FINANCING AVAILABLE!⁽¹⁾ AVAILABLE ON SELECT MODELS.

Extra Savings **In Stock Now!**
"We will meet or beat our competition"

CHARLES D. STAHL SALES & SERVICE
RIVER RD., MARCY • 315-733-1996
SNELLS BUSH RD., LITTLE FALLS • 315-823-1982

⁽¹⁾ Offer Subject to Credit Approval. Some Restrictions Apply. See Store Associate for Details.
*Product Price — Actual retail prices are set by dealer and may vary. Taxes, freight, setup and handling charges may be additional and may vary. Models subject to limited availability.
Specifications and programs are subject to change without notice. Images may not reflect dealer inventory and/or unit specifications.
773-05929 © 2015 Cub Cadet cubcadet.com

Cub Cadet

Ole Sal's Café & Creamery

Open Year Round
410 Canal Place | In the Stone Mill
Little Falls, NY 13365 | www.olesals.com
315.868.0910 | Owner: Chris Connolly

NATHAN GALINSKY Apartments

Now Accepting Applications for 62 Years & Up

Subsidized Housing
1 Bedroom Apartments
Senior Citizens and Mobility Impaired

Sherry Wellington, Manager
105 Protection Ave., Herkimer
Phone: (315) 866-3611 • Fax: (315) 866-6074
www.nathangalinsky.com

NEW Smoke Free Policy

EQUAL OPPORTUNITY HOUSING

DANS AUTO REPAIR
Old Fashioned Service and Honesty

Electrical • A/C • ABS
Check Engine Lights and More!

We Service Most Makes & Models
Call For Appointment

6500 State Route 5
Little Falls, NY 13365
Shop Phone **315-508-5061**
Cell 315-868-8166 or 315-868-1575

DAN HIGHT
Owner/Operator



The Sandwich Chef

Serving Breakfast & Lunch
Homemade Soups & Salads & Desserts
Now Serving Soft Ice Cream
Mon-Sat 7:30am-5pm
Sun 9am-4pm

Bring in the ad - Get a Cone for \$1

Call (315) 508-5192
604 E. Main St., Little Falls, NY
Full Menu on Facebook
(Expires 6/1/16)

VALLEY RESTAURANT EQUIPMENT

(315) 823-0542
542 East Main St.
LITTLE FALLS NY 13365
valleyequipment@live.com

**Now Carrying
A New Line Of Equipment
Party Supplies**

Paper Products, Sterno, Smallware,
Kitchenwares, Unique Kitchen Gadgets
NEW & USED EQUIPMENT

• Gift Certificates •
New Location on 2nd Floor Over Ruggiero's

Spring in
Little Falls





HARDWARE STORE
Vinyl Replacement Windows by Anderson
Also Wayne Dalton Garage Doors Direct To You Price
Our Founders Famous Words,
"Your number one and we are Lumber one"

• New For 2016 •
Outside Sales Person to Quote you on all Your Building Projects
We Offer Local Contractor Referrals for Installation on Windows,
Doors, Garage Doors and Any Other Building Project with Our Products

\$1.99 Lin/Ft Sheet Roofing
\$1.49 Lin/Ft on Seconds Steel Roofing. Many Colors In Stock.

Full line of Building Materials - Customer Steel Orders including Garages, Pole Barns, House Packages. Complete line of Treated Lumber for your deck projects. Also carrying a line of complete seamless gutters.

40 Years Experience

We Carry The #1 Brands in the Home Improvement Industry!

LARSON STORM DOORS
STONECRAFT STONE VENEER
ROXUL The Better Insulation

WINDOWS & DOORS
Georgia-Pacific VINYL SIDING & ACCESSORIES
Weatheredge ROOFING

Let our Experienced staff quote you for your complete building projects including: House, Pole barn and deck packages
Mike Robert, Erik, Bert, Adam, Trevor, Tom Barderson

40 McKinley Rd., Dolgeville (315) 429-9962
525 E. Mill St., Little Falls (315) 823-1709

Ann Street Liquor

18 North Ann Street, Little Falls, NY
315-823-0320

Stop by April 21st
and Receive **10% OFF**
All Organic Wines

Monday - Saturday 9-9pm Sunday Noon - 4pm



Winter Clearance Sale!

Now thru April 30th, 2016 - Don't Wait!

"25% OFF" on "Alpaca"
Sweaters, Socks, Hats, Gloves,
Mittens, Jackets, Vests, Capes,
Blankets, Scarves & Fur Products!!

Up to 50% OFF on many Clearance Items!
Discount applies to items with regular Everyday Low Pricing. No Rainchecks or Layaways.



www.pacagardens.com / Like us on Facebook "Paca Gardens"

PACA GARDENS

27 West Main St., Little Falls, NY 13365
Mon - Fri: 10am - 5pm / Sat: 10am - 4pm
Ph. 315-823-1100 Mastercard/Visa/Discover/Am Express

Pat DaBiere Presents:

STAND-UP COMEDY NIGHT AT:

Travelodge - Little Falls

20 Albany Street - Little Falls NY
Saturday Night - April 16TH!
9PM Show Time

Only \$15.00 Per Person!
Call 315-823-4954 To Reserve Your Seats!

Headliner  Joe has performed as the warm up comedian for NBC's "Who wants to be a millionaire" ESPN's "Room for Debate" & MSNBC's "Crowd Rules" He has performed at The MGM Grand in Las Vegas NV The Borgata Hotel & Casino in Atlantic City NJ plus Carnival & Royal Caribbean Cruise Lines. Joe has opened for industry greats like; Chris Rock, Brad Garrett, Brian Regan, Dom Irrera, Louie Anderson & for a 5 year run he was a regular & only opener for the comedy legend David Brenner.

Featuring  **Joe Greene**
with performances at
The Saratoga Comedy Club
& The Broadway Comedy Club!

Host/MC  **Pat DaBiere**
With Appearances At
Wisecrackers Comedy Club
& The Proctor's Theater!

Dinner Specials Available!

Call 315-823-4954 To Reserve Your Seats!

Comfort Foods Made Fast And Healthy

by Healthy Exchanges

Pineapple Green Beans

A taste of Hawaii!

1/2 cup chopped onion

1 (8-ounce) can pineapple tidbits, packed in fruit juice, drained and 1/4 cup liquid reserved

1/4 cup water

1 tablespoon cornstarch

1 1/2 teaspoons reduced-sodium soy sauce

2 cups frozen cut green beans, cooked, rinsed and drained

1. In a large skillet sprayed with butter-flavored cooking spray, saute onion for 5 minutes.

2. In a covered jar, combine reserved pineapple liquid, water and cornstarch. Shake well to blend. Pour mixture into skillet with onion. Stir in soy sauce. Add green beans and pineapple tidbits. Mix gently to combine.

3. Continue to cook over medium heat for 6-8 minutes or until mixture thickens and is heated through, stirring constantly. Divide into 4 servings.

Tip: If you can't find tidbits, purchase pineapple chunks and coarsely chop.

* Each serving equals: 76 calories, 0g fat, 1g protein, 18g carb., 68mg sodium, 37mg calcium, 2g fiber; Dia-

betic Exchanges: 1 Vegetable, 1/2 Fruit; Carb Choices: 1.

(c) 2016 King Features Synd., Inc.

Oak Hill Motors & RV
www.oakhillsales.com

RV Sales • Service • Parts
Southbay Pontoons • Forest River RV's

Financing Available

Over 100 RV's/Campers in the Lot

Paul
(315) 895-7139

Jake
(315) 866-3030

4246 St. Rte. 5, Frankfort, NY

CRAZY OTTO'S EMPIRE DINER



**Buy 1 Full Priced
Breakfast, Lunch or Dinner*
receive the
Second One FREE**

*equal or greater value

Cannot be combined with any other offers. Offer Expires 5/1/16

100 W. Albany St. • Herkimer, NY 13350
315-866-8801

ROLLING ANTIQUER'S OLD CAR CLUB

★★ **51ST ANNUAL** ★★

**ANTIQUE
Auto Show**

Car Parts, Antiques & Collectibles Market

Chenango County Fairgrounds
168 East Main St., Norwich, NY

MEMORIAL DAY WEEKEND 2016

Saturday, May 28th
Muscle Cars & Street Rods

Sunday, May 29th
Antique & Classic Cars

General Admission \$5
Children under 12 FREE



**Open Daily
8 am - 5 pm**

Motorcycles
Military Vehicles
Antique Engines
Food & Beverages
DJ Music Service
FREE Shuttle Bus

GENERAL ANTIQUES
607-334-5038

CAR PARTS
607-316-8146

MUSCLE CARS
(2002 & Older)
607-334-8549

**ANTIQUE
ENGINE DISPLAY**
607-316-8146

**ANTIQUE &
CLASSIC CARS**
(1991 & Older)
607-829-6268

Vendor & Registration Forms at RAOCC Website:
<http://www.raocc.org>

**No Pets.
No Refunds.**



**It's Time To Grill
and Sit In Front
of the Fire!**



Many Styles to Choose From

**Buy a Fireplace & get a
FREE cord of wood.**

STOP IN NOW!

Mohawk Valley Hearth & Heating
Sales, Service and Installation

1027 E. German St. Ext. (Oak Hill Plaza) Herkimer, NY 13350 • 315-866-6848
mohawkheating@yahoo.com • www.mohawkvalleyhearth.com
Open 9am-5pm Mon.-Fri. • 9am-2pm Sat. • Closed Sun.



315-868-8207

**12 Years
Experience!**

Aaron Swarey
Canajoharie, NY

Shingle • Metal • Rubber
WE'VE GOT YOU COVERED!
Free Estimates - Family Owned

No Games! No Gimmicks!

No Monkey Business!

JUST ONE LOW PRICE!!

Beat The Spring Rush Call Today

HERKIMER • FULTON
HAMILTON • OTSEGO

BOCES
Learning for Life



Adult LPN Program

OFFERING HEALTH CARE
TRAINING FOR OVER 50 YEARS

ACCEPTING APPLICATIONS
FOR SEPTEMBER 2016 CLASSES
PRACTICAL NURSING

- Full time 10 months • Part time 20 months days
- Part-time 20 months evenings w/Saturday clinicals

Financial Aid is available to qualified applicants

At Herkimer BOCES we have a long tradition of training practical nurses. Our graduates come from diverse backgrounds and ages. Some come with no health care experience and are in need of training. Others are building upon existing nursing skills. One thing all our students hold in common, is a desire to continue their education and provide a brighter future for themselves and their families.

For complete LPN course description and application process visit on the web at: lpn.herkimerboces.schoolfusion.us or call 315-895-2210 Ext. 1 • 77 E. North St., Ilion, NY

New Location

**Sales Professional
needed for our advertising team!**

Successful candidates will be highly motivated, articulate and possess sophisticated prospecting skills. Must be able to develop leads, reach decision-makers, and deliver client-specific print advertising solutions. Must have valid NYS driver's license.

Solid producers seeking a fast-paced, friendly work environment, and competitive salary plus commission should email resume and cover letter to jsnyder@leepub.com.

Lee Newspapers, Inc.
Palatine Bridge, NY



**Farm &
Tool Line**

682 Fordsbush Road
Fort Plain, NY 13339
518-527-6838



NOT JUST YOUR AVERAGE FARM STORE!

- Redmond Products
- Keystone Mills Products
- Animal Feed: Small to Large
- Organic & Non-organic
- Animal Health Speciality Products

- Molasses
- Salt Blocks
- Udder Comfort
- Dog Food
- Barn Dri
- Gypsum Products
- Shavings

KEYSTONE MILLS
Sowing Agriculture Since 1894

Our goal is to offer quality products at a fair price.



Area Church Services

DOLGEVILLE
NEW HOPE CHRISTIAN FELLOWSHIP
 Pastor Pat Andreoli
 32 Spencer St.
 Sunday School 9:30 AM
 Sunday Worship 10:30 AM
 Tuesday Bible Study 7 PM

GRACE BAPTIST CHURCH OF DOLGEVILLE
 Paster Len Byarty
 12 Van Buren St.
 Sunday School (All Ages) 10-11 AM
 Morning Worship 11-12:30 PM
 Lunch 12:30-2 PM
 Afternoon Worship 2-3 PM

DOLGEVILLE UNITED METHODIST CHURCH
 Rev. Jack A. Ford
 21 N. Helmer Ave.
 Church Phone 429-7381
 Sunday Church Service
 Oppenheim @ 9:30 AM
 Dolgeville @ 11 AM

DOLGEVILLE CHRISTIAN FELLOWSHIP
 Pastor Marvin Isum
 3 Elm St.
 Phone 429-8390
 Sunday Worship 10:30 AM
 Mid-week Service Tuesday 7 PM

UNITED LUTHERAN PRESBYTERIAN PARISH
 26 E. Faville Ave.
 Worship 11 AM

ST. JOSEPH'S ROMAN CATHOLIC CHURCH
 Deacon Jim Bower, Administrator
 Rev. T. Healy, Sacramental Minister
 31 N. Helmer Ave.
 Phone 429-8338
 Sunday Mass 9 AM

HERKIMER
SS PETER and PAUL
ORTHODOX CHURCH
 Very Rev. John Udics
 305 Main Rd., East Herkimer
 Phone 866-3272
 Saturday Evening Vespers 4 PM
 Sunday Divine Liturgy 9:30 AM
 Holy Day Liturgy 9:30 AM

TEMPLE BETH JOSEPH
 Rabbi Ronald Kopelman
 327 N. Prospect St.
 Phone 866-4270
 Friday 8 PM • Saturday 9 AM

ST. FRANCIS de SALES CHURCH
 Rev. Mark Cunningham, Pastor
 219 N. Belling St.
 Phone 866-4240
 Saturday Vigil Mass 4 PM
 Sunday Mass 8 & 10:30 AM

HERKIMER
CHURCH OF SAINTS
ANTHONY and JOSEPH
 Rev. Quy Vo, Pastor
 229 S. Main St.
 Phone 866-6373
 Saturday Vigil Mass 6 PM
 Sunday Mass 10 AM

REDEEMER CHURCH
 Pastor Michael Servello
 931 Herkimer Rd.
 Utica, NY 13503
 Phone 792-4748
 Saturday 6 PM
 Sunday 9 & 11 AM

OAK RIDGE FREE METHODIST CHURCH
 Pastor Chris Schumske
 838 W. German St.
 Sunday School (All Ages) 9:30-10:20 AM
 Worship Service 8:30-10:30 AM
 with iPraise for the children (K-5th grade)
 Phone 866-0575

THE FIRST BAPTIST CHURCH OF HERKIMER
 North Washington & Green St.
 Sunday Worship 10 AM
 Phone 866-4984

UKRAINIAN ORTHODOX CHURCH OF ST. MARY'S PROTECTRESS
 326 Moore Ave.
 Sunday Divine Liturgy 10 AM
 Holy Day Liturgy 9 AM
 Phone 866-1336

NEW LIFE CHURCH
 Pastor David Hayner
 337 Protection Ave.
 Phone 866-1164
 www.nlc-mc.org
 Worship 10 AM
 Wednesday Worship 6:30 PM

TRINITY EVANGELICAL LUTHERAN CHURCH
 Rev. Ann Zimmerman, Pastor
 Corner of West German & Henry Streets
 Phone 866-6474
 Sunday Services 8 AM Spoken
 Sunday Worship Service
 10:30 AM with Music
 Bible Studies on Thursday Mornings at 10 AM

THE SALVATION ARMY
 Lieutenants John and Lori Wood
 429 N. Prospect St.
 Phone 866-1240
 www.thesalvationarmy.org
 Sunday School 10 AM
 Morning Worship 11 AM

FIRST UNITED METHODIST CHURCH OF HERKIMER AND LITTLE FALLS
 Pastor Janet Gleason
 Prospect St. & Park Ave.
 Sunday Worship 8:30 & 10 AM
 Wednesday 7 PM
 Sunday School 10 AM

HERKIMER
CHURCH OF JESUS CHRIST
OF LATTER-DAY SAINTS
(MORMONS)
 Branch President Blake Francisco
 Gros. Blvd., East Herkimer
 Phone 315-866-8095
 Priesthood/Relief Society 12:10 PM
 Sunday School 11:20 AM
 Sacrament Meeting 10 AM
 Family History Center hours by appointment; please leave a message at 315-866-7189

HERKIMER REFORMED CHURCH
 102 Church St.
 Phone 866-1523
 Worship 9:30 AM
 Sunday School 11 AM
 Shepherd's Table:
 Tuesday 11-12:30 PM
 Thursday 11:30-12:30 PM
 Shepherd's Table Dinner:
 First & Third Tuesday 6 PM

CHRIST EPISCOPAL CHURCH
 Rev. Jill Stellman
 300 N. Main St.
 Church Office 866-0551
 Email christherk@verizon.net
 Sunday Services:
 Sunday School 9:00 AM
 Holy Eucharist 9:30 AM

LITTLE FALLS
FIRST BAPTIST CHURCH
 555 Albany St.
 Morning Worship will begin at 10:15 AM
 Rev. Chris J. Wintermute will be speaking this morning.
 Nursery (infants through age 4)
 Junior Church (K-4) during Morning
 Worship Service
 Sunday School Classes 9 AM
 (nursery through adult)

Morning Worship Service 11 AM and is broadcast live over radio station WIZR, 930 on the AM dial with a one week delay.
 Monday School Board Meeting 6:30 PM
 Tuesday Trustee Meeting 7 PM
 Wednesday Final Bible Study & Prayer
 Time at homes 7 PM
 Thursday Choir Practice 7 PM

HOLY SPIRIT POLISH NATIONAL CATHOLIC CHURCH
 Father Rafael Dadello
 615 E. Gansevoort St.
 Phone 823-0793
 Sunday Mass 11 AM

ST. PAUL'S UNITARIAN UNIVERSALIST CHURCH
 Minister Jeffrey J. Frank
 Mark Bunce, Organist
 565 Albany St.
 Phone 823-2284
 Sunday Service & Religious Education 10 AM

LITTLE FALLS
HOLY FAMILY PARISH OF THE
ROMAN CATHOLIC COMMUNITY OF
LITTLE FALLS
 Deacon Jim Bower, Administrator
 Rev. T. Healy, Sacramental Minister
 763 E. Main St.
 Phone 823-3410
 Saturday Vigil Mass 4 PM
 Sunday Mass 10:30 AM

EMMANUEL EPISCOPAL CHURCH
 Father Steven A. Scarcia, D.Min, rector
 588-594 Albany St.
 Sunday Schedule:
 High Mass, Rite II 10 AM
 Nursery & Sunday School 9:45 AM (Sept.-May)
 Fellowship Coffee Hour 11:15 AM
 Choir Rehearsal 11:30 AM
 Holy Day Masses as announced
 Confessions by appointment

FIRST ASSEMBLY OF GOD
 Senior Pastor Timothy Parisi
 559 E. Jefferson St.
 Phone 823-4043 • firsttagf@gmail.com
 Sunday Morning All Worship 10 AM
 Thursday Bible Study 6:30 PM

HOLY TRINITY LUTHERAN CHURCH
 512 E. Gansevoort St.
 Sunday Worship 9 AM
 Sunday School 9 AM
 Wednesday Services 12:10 PM & 7 PM

FIRST PRESBYTERIAN CHURCH
 The Rev. Ruth Kuo
 18 Jackson St.
 Worship 9 AM

MIDDLEVILLE
MIDDLEVILLE UNITED METHODIST
 Rev. Robert Lindsay
 24 Rte. 29
 Phone 845-8730
 Sunday School 9:30 AM
 Worship Service 9:30 AM

MOHAWK
DENNISON CORNERS COMMUNITY CHURCH
 Pastor Donald King
 219 Robinson Rd. • Phone 866-5215
 Sunday:
 Sunday School 9:45 AM
 Morning Worship 11 AM
 Evening Worship 6 PM
 Wednesday Prayer 7 PM

GRACE EPISCOPAL CHURCH
 Rev. Sally Heiligman
 7 E. Main St.
 Phone 866-5233 or 866-3540
 Holy Eucharist 10 AM

MOHAWK
MOHAWK REFORMED CHURCH
 Rev. Brian Engel, Pastor
 20 S. Otsego St.
 Phone 866-4292
 Email mohawkpastor@verizon.net
 Follow us on Facebook
 Morning Worship:
 10:30 AM Sept. - June • 9:30 AM July - Aug.
 Youth Sunday School (Pre-K - Sr. High) 9 AM
 Adult Sunday School (Men, Women & Couples) 9:30 AM
 September - June

EMMANUEL BIBLE CHURCH
 Pastor Gary Wilcox
 54 W. Main St. • Phone 717-3011
 Sunday School 9:45 AM
 Morning Worship 11 AM
 Fellowship Lunch 12:30 PM
 Afternoon Bible Study 1:30 PM
 Wednesday Prayer & Bible Study 6 PM

CHURCH OF THE BLESSED SACRAMENT
 Sr. Mary Jo Tallman, CSJ,
 Parish Life Director
 Rev. Mark Cunningham,
 Sacramental Minister
 71 E. Main St.
 Phone 866-1752
 Saturday Vigil Mass 5:30 PM
 Sunday Mass 9:30 AM

CHRISTIAN BIBLE CHURCH
 H. Ed Reed, Pastor/Teacher
 167 Ward Rd.
 Phone 858-1282
 www.christianbiblechurch.us
 Sunday School 9 AM
 Sunday Worship 10 AM
 Wednesday Bible Study
 & Prayer Meeting 7 PM

THE WORD CHRISTIAN CENTER
 Pastor Gene Kipper
 27 E. Main St.
 Phone 868-1790
 Sunday Services at 10 AM
 Intercession - Tuesdays at 7 PM
 Free Community Dinner the last
 Thursday of the Month at 6 PM

NEWPORT
FIRST BAPTIST CHURCH OF NEWPORT
 7497 Main Street
 Pastor's Phone 315-790-1877
 Sunday Worship at 9:45am

UNITED METHODIST
 Rev. Robert Lindsay
 Phone 845-8730
 Sunday School 11 AM
 Morning Service 11 AM

NEWPORT
COLD BROOK UNITED METHODIST CHURCH
 Pastor Genett Timlin
 467 Main St.
 Sunday Worship 10:30 AM

KUYAHOORA COMMUNITY CHURCH
 Pastor Dwayne Durand
 West Canada Valley
 High School Auditorium
 5447 St. Rt. 28
 Mailing Address PO Box 50
 Middleville, NY 13406
 Phone 315-292-1303
 www.kuyahorracc.org
 Weekly Service Sunday 10:08 AM

ST. JOHN THE BAPTIST CATHOLIC CHURCH
 Rev. Quy Vo, Pastor
 St. John the Baptist Parish
 7516 N. Main St. • Phone 845-8017
 Monday & Wednesday 9 AM
 Saturday Vigil Mass 4 PM
 Sunday Mass 8 AM

PAINES HOLLOW
PAINES HOLLOW UNITED METHODIST
 Pastor Peg Donaghy
 Rtes. 167 & 168 • 518-568-7604
 Worship 9:30 AM

SALISBURY CENTER
FULL GOSPEL ASSEMBLY OF GOD
 Pastor Robert Brent
 106 Plant Road
 Sunday Worship 11 AM
 with Children's Church offered
 during the service



BIG M SUPERMARKET
 Lamberson St.,
 Dolgeville • 429-8518



Pohl's
 Area's Leading
 Wallcovering Store
315-823-2640
 634 E. Main Street
 Little Falls, NY 13365

SALISBURY MOTOR CAR CORP.
The AUDI/VW SPECIALIST
 Rt. 29
 Salisbury Center, New York
315-429-9902



WALMART
HERKIMER



115 Court Street
 Herkimer, NY
(315) 866-4590
40 West James Street
 Richfield Springs, NY
(315) 858-1810
Same Ownership



COLLIS True Value HARDWARE
Help Is Just Around The Corner
 104 N. Main St., Herkimer,
 Ph. 866-0826

Humphrey Memorials, Inc.
 3051 State Rte. 28,
 Herkimer, NY 13350
 Monument Sales & Engraving
 Professional Memorial Cleaning
 Specialty Sandblast & Etching
 315-866-4471
 humphreymemorials.com

Big Willy's Pizzeria
894-2057 • 894-7855
121 East Main St.
Frankfort, NY

Main Street Chiropractic
 Health and Wellness Center
 • Flexible Walk in Hours
Dr. Kathleen Fusco
 • Insurance Not Necessary
8841 N. Main Street
Poland, NY 13431
(315) 826-7772



Gina Trzepacz - Timpano
 1309 Champlin Ave. PO Box 123
 Yorkville, NY 13495
MEMORIALS • PRE-PLANNING
MEMORIAL RESTORATION
 Ph/Fax: 315-736-1781 Cell: 315-723-7445
 gina@yorkvillememorials.com

"It's Always Worth A Trip To Zipp"
ZIPP True Value Hardware
True Value
 START RIGHT. START HERE.®
 73-77 N. Main St. Dolgeville
315-429-9761

Whiter-Hendrix Funeral Home, Inc.
Since 1893
 "When Experience Matters"
100 Otsego Street
Ilion, New York
894-3781

Superior Home Health Care
Providing Care In The Home
(315) 866-7932
 703 Middleville Rd.,
 Herkimer, NY 13350



Century 21
 Rob Diedrich Associates
(315) 866-7702
"Our Service is Worth It's Weight In Gold"
 55 East Main Street, Mohawk

W.E. AUTENRITH SONS, INC.

Funeral Home
845-8532
 Newport, NY
Eric J. Newman, Director



NTCO NET
Newport Telephone Company



Quality Used Cars With a Warranty!
WHITCOMB AUTO SALES
 6500 St. Rt. 5, Little Falls, NY 13365
Thomas C. Whitcomb, Owner
Phone 315-823-1320
 www.whitcombautosales.com



RADIO RODNEY WINS AGAIN! Can you guess which car belongs to Rodney?

Answer: Number 3.

Junior Whirl

by Charles Barry Townsend

CAST YOUR EYES ON THIS PUZZLE!

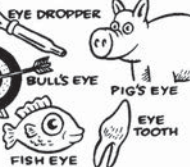
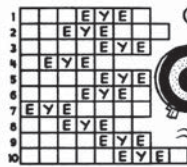

The "eyes" have it when it comes to interesting words. The grid to the left has room for 10 words, and they all contain an "eye." Hints are given below.

1. What the bad golfer did.
2. Native American buffalo hunters.
3. An expert marksman.
4. Ruined auto paint job.
5. What the weary cowboy needed.
6. How the weary cowboy came into town.
7. To look over.
8. What the predator did.
9. Ohio's nickname.
10. What they did before the king.

Answers: 1. Bogeys 2. Cheyenne 3. Deadeye 4. Keyed 5. Shrove 6. Kowtow 7. Eyeball 8. Prayed 9. Buckeye (State) 10. Curses

FREDDIE THE FEATHER Fancier! The other day, Freddie bought 20 birds for \$20. Pigeon cost \$4 each, canaries 50 cents each, and budgies 25 cents each. Can you figure out how many of each he bought?



Answer: He bought 3 pigeons, 15 canaries and 2 budgies.

LINK-UPS! Here's a list of 12 short words, divided into two columns. Turn them into six longer words by linking them together. To do this, draw a line from one word in the left column to one word in the right.

1. RIP HERS
2. OVER LED
3. CAP ROT
4. BUST PLED
5. WIT ABLE
6. PAR AGES

Answers: 1. Rippedled 2. Capable 3. Parrot 4. Bustled 5. Withered 6. Parrot



Mega Maze

"Cowards die many times before their deaths; the valiant never taste of death but once."

Sticklers Answer

R.F.D.



by Mike Marland



The trouble with practical jokes is that very often they get elected.
~Will Rogers

Mega Maze

©2016 King Features Syndicate, Inc.

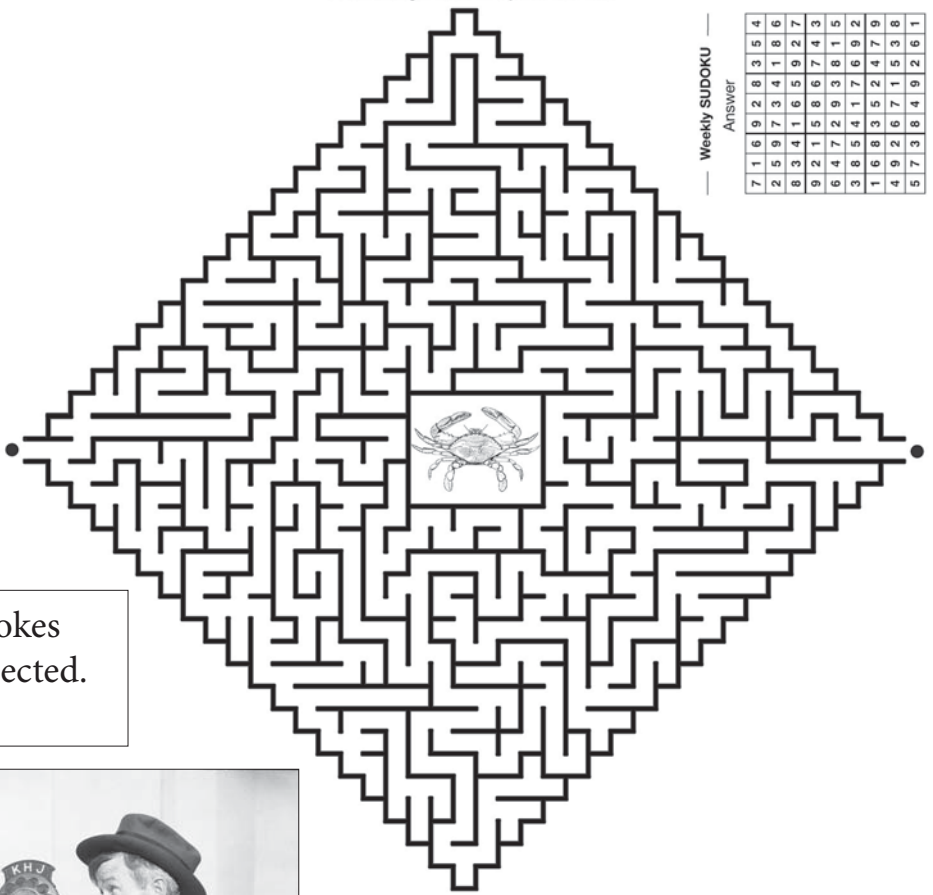

Weekly SUDOKU Answer

7	1	6	9	2	8	3	5	4
2	5	9	7	3	4	1	8	6
8	3	4	1	6	5	9	2	7
9	2	1	5	8	6	7	4	3
3	6	5	4	1	7	6	9	2
1	6	8	3	5	2	4	7	9
4	9	2	6	7	1	5	3	8
5	7	3	8	4	9	2	6	1

STICKELERS by Terry Stickels

Below is a jumbled quote from Shakespeare ("Julius Caesar"). See if you can unscramble the words to come up with the correct quote.

"Death times many before; cowards but taste once never the die of their valiant deaths."

©2016 King Features Syndicate

King Crossword

- ACROSS**
- 1 Not as much
 - 5 Ump
 - 8 "The Da Vinci —"
 - 12 Send forth
 - 13 Hosp. section
 - 14 From the start
 - 15 Turkish city
 - 17 Pleasant
 - 18 Urban carrier
 - 19 "Fear —"
 - 21 Grown-up
 - 24 Verdi opera
 - 25 Zilch
 - 26 Crusoe or Gilligan
 - 30 Actor
 - 31 Danson
 - 32 Suggest
 - 33 First lady
 - 34 U-235 and U-238
 - 35 Actress Barbara
 - 36 John Irving's "A Prayer for — Meany"
 - 37 Part of WWW
 - 38 Panhandler
 - 41 London's — Gardens
 - 42 Breather?
 - 43 Columbus' benefactor
 - 48 Exam type
 - 49 Suitable
- DOWN**
- 1 Floral garland
 - 2 Type squares
 - 3 Perch
 - 4 Not wobbly
 - 5 Barbecue fare
 - 6 Old French coin
 - 7 Satisfies
 - 8 Moulin Rouge dance
 - 9 Taking care of business
 - 10 Arp's art
 - 11 Basin accessory
 - 16 Wacko
 - 20 "An apple — ..."
 - 21 Opposed
 - 22 Accomplishes
 - 23 Loosen
 - 24 Colorado ski mecca
 - 26 Regal
 - 27 Cherished
 - 28 Satan's specialty
 - 29 Tear
 - 31 Midwestern
 - 34 Two-position switch
 - 35 NYC area, with "the"
 - 37 Charlotte's creation
 - 38 Rorschach picture
 - 39 Modern-day coin
 - 40 Summertime pest
 - 41 Perry of pop
 - 44 Hot tub
 - 45 Director
 - 46 Allow
 - 47 — Baba

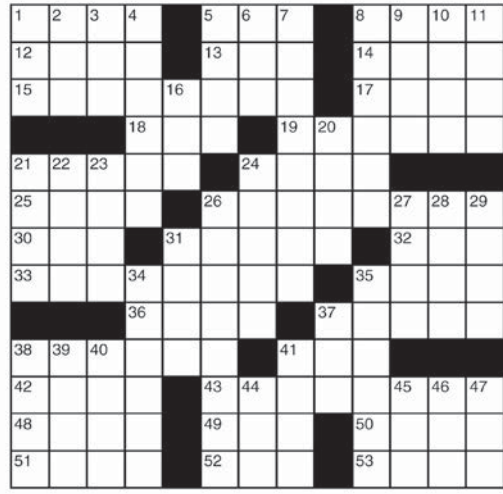

HOCUS-FOCUS BY HENRY BOLTINOFF

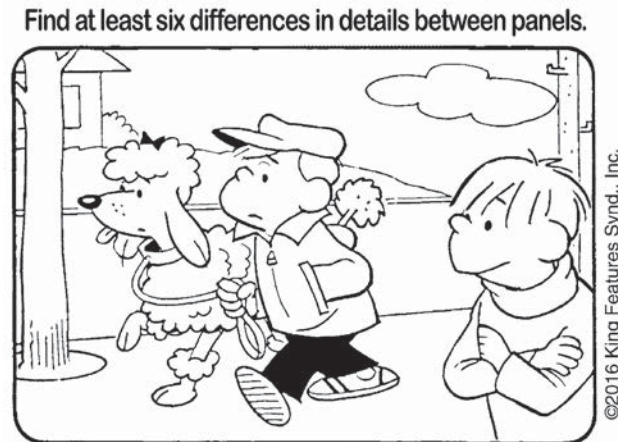

Find at least six differences in details between panels.

Differences: 1. Tree guard is missing. 2. Bow is smaller. 3. Tail is shorter. 4. Cloud is different. 5. Fireplug is missing. 6. Crossed arms are switched.

New! 24 HOCUS FOCUS puzzles \$3.50 • 24 Volumes • Order at: rbmamall.com

Weekly SUDOKU

by Linda Thistle

		6		2	8			5
2			7				1	
	3			6				7
	2				6			3
6				9		8		
		5	4					9
		8	3			4		
	9				1			8
5				4				6

Place a number in the empty boxes in such a way that each row across, each column down and each small 9-box square contains all of the numbers from one to nine.

DIFFICULTY THIS WEEK: ★★★

★ Moderate ★★ Challenging
★★★ HOO BOY!

© 2016 King Features Synd., Inc.

NEED A ROOF?

\$100.00

Instant Rebate on a New Metal Roof

Expires 06/01/2016

Call Your Recommended Roofer!



Angie's list

Your Satisfaction is Our Guarantee!

If you want to be serious.... you want Panda Roof!

“\$\$\$SAVE\$\$\$”

Call Now For Your 17 Point Roof Inspection

We Finance!
Call for Details



315-823-0139

A Panda Metal Roof is a happy roof. This stuff is tough.
Coupon expires 6-1-16

Herkimer ARC looking for an unsung hero

Herkimer ARC President/CEO Kevin Crosley, recently announced the agency is seeking nomi-

nations for the 2016 Person-to-Person Award, which recognizes an individual in Herkimer Coun-

ty who enables people with disabilities to achieve their full potential in the community and to live enriched lives.

The Herkimer ARC is looking for that person who is an unsung hero. The award is presented each year to honor someone who shows compassion and respect in a personal relationship with a person with a disability, who demonstrates unconditional love and acceptance through understanding, and/or whose acts of kindness contribute to a person's quality of life.

The award will be presented at the Herkimer ARC's Annual Meeting and Dinner on Wednesday, May 18. To send a letter of nomination or for more information, mail to: Person-to-Person, Herkimer ARC, Box 271, Herkimer, NY 13350. Call Jackie Lewis at 315-574-7000, or email jlewis@herkimerarc.org. All nomination letters must be received by Wednesday, April 27.

For more information regarding the Herkimer ARC, visit www.herkimerarc.org.

Rudy's
Express Tuxedo
"We suit your needs"

Tux Rentals

*For Proms
Weddings
& Formal Events*



Call for appointments
& information
315-717-3719
David Bunce

Ready. Set. Save on Kubota's Z700 Series Zero-Turn Mowers.

GET SET TO SAVE

SALES EVENT



\$0 Down, 0% A.P.R. Financing for 48 Months*

Offer ends 6/30/16.



2991 State Highway 5S • Fultonville, NY
518-853-4500
www.randallimpls.com



*50 down, 0% A.P.R. financing for up to 48 months on purchases of new Kubota Z700 Series equipment is available to qualified purchasers from participating dealers' in-stock inventory through 6/30/2016. Example: A 48-month monthly installment repayment term at 0% A.P.R. requires 48 payments of \$20.83 per \$1,000 financed. 0% A.P.R. interest is available to customers if no dealer documentation preparation fee is charged. Dealer charge for document preparation fee shall be in accordance with state laws. Inclusion of ineligible equipment may result in a higher blended A.P.R. 0% A.P.R. and low-rate financing may not be available with customer instant rebate offers. Financing is available through Kubota Credit Corporation, U.S.A., 3401 Del Amo Blvd., Torrance, CA 90503, subject to credit approval. Some exceptions apply. Offer expires 6/30/2016. See us for details on these and other low-rate options or go to www.kubota.com for more information. Optional equipment may be shown.



In the spring,
at the end of
the day,
you should
smell like dirt.
- Margaret Atwood

**Wait Staff
Bartenders &
Cooks
Wanted**

Qualified Candidates Only
Please Call
518-222-9312
for appointment

Gohde Enterprises

We have equipment rentals for any size project, big or small



**Dumpster Rentals
Now Available**

Daily • Weekly • Monthly
607-264-9347
Cell: 607-287-8411

Country Editor

PO Box 121, 6113 State Hwy. 5
 Palatine Bridge, NY 13428
 800-836-2888 • Fax: 518-673-2381
 classified@leepub.com

- Number / Classification**
- 20 Air Compressors
 - 25 Air Tools
 - 35 Announcements
 - 45 Antiques
 - 55 Appraisal Services
 - 75 ATV
 - 80 Auctions
 - 82 Auto Body
 - 110 Bedding Plants
 - 120 Bees-Beekeeping
 - 130 Bird Control
 - 140 Books
 - 155 Building Materials/Supplies
 - 157 Building Repair
 - 160 Buildings For Sale
 - 161 Bulk Foods / Spices
 - 165 Business Opportunities
 - 170 Butchering Supplies
 - 173 Carpentry
 - 175 Cars, Trucks, Trailers
 - 180 Catalogs
 - 182 Catering
 - 190 Chain Saws
 - 195 Cheesemaking Supplies
 - 205 Christmas
 - 214 Clocks & Repair
 - 215 Collectibles
 - 216 Clothing
 - 235 Computers
 - 253 Consignment
 - 265 Construction Equipment For Rent
 - 275 Construction Machinery Wanted
 - 277 Construction Services
 - 280 Construction Supplies
 - 312 Crafts
 - 325 Custom Butchering
 - 330 Custom Services
 - 360 Deer-Butchering & Hides
 - 370 Dogs
 - 410 Electrical
 - 415 Employment Wanted
 - 440 Farm Machinery For Sale
 - 445 Farm Machinery Wanted
 - 447 Farm Market Items
 - 460 Fencing
 - 470 Financial Services
 - 480 Fish
 - 483 Flooring
 - 495 For Rent or Lease
 - 500 For Sale
 - 510 Fresh Produce, Nursery
 - 525 Fruits & Berries
 - 527 Furniture
 - 529 Garage Sales
 - 530 Garden Supplies
 - 535 Generators
 - 537 Gifts
 - 575 Greenhouse Supplies
 - 585 Guns
 - 587 Hair Styling
 - 589 Hardware
 - 600 Health Care/Products
 - 605 Heating
 - 610 Help Wanted
 - 653 Hotel / Motel
 - 683 Jewelers
 - 700 Lawn & Garden
 - 711 Lessons
 - 760 Lumber & Wood Products
 - 790 Maple Syrup Supplies
 - 805 Miscellaneous
 - 810 Mobile Homes
 - 811 Monuments
 - 812 Multi Media
 - 813 Music
 - 815 Motorcycles
 - 817 Nails
 - 820 Nurseries
 - 910 Plants
 - 950 Real Estate For Sale
 - 955 Real Estate Wanted
 - 960 RVs & Motor Homes
 - 975 Rentals
 - 980 Restaurant Supplies
 - 1040 Services Offered
 - 1075 Snowblowers
 - 1080 Snowmobiles
 - 1096 Sports
 - 1109 Thrift
 - 1140 Trailers
 - 1147 Trains
 - 1148 Travel
 - 1165 Trees
 - 1170 Truck Parts & Equipment
 - 1180 Trucks
 - 1187 Vacuum
 - 1190 Vegetable
 - 1200 Veterinary
 - 1205 Wanted

Announcements

ADVERTISING DEADLINE
FRIDAY • 2:00 PM
 (Week Prior to Each Friday Dated Paper)
 For as little as \$4.00 - place a classified ad in
The Country Editor
 Call Peg at **1-800-836-2888**
 or **518-673-0111**
 or email classified@leepub.com

Announcements

SELF INKING STAMP - Great for Raffle Tickets. \$20.00+ tax. Call Beth at Lee Newspapers Inc. 518-673-0101

DAVE'S LARGE INDOOR SALE: 166 Summit St., Mohawk in Manion Heights right off Rt. 5S. New items weekly. Every Fri.&Sat. 9-5 through the month of April. Tools, hunting, fishing, books, knick knacks, radios, household, furniture, sewing machines, craft wood, toys & more.

CHECK YOUR AD - ADVERTISERS should check their ads on the first week of insertion. Lee Publications, Inc. shall not be liable for typographical, or errors in publication except to the extent of the cost of the first weeks insertion of the ad, and shall also not be liable for damages due to failure to publish an ad. Adjustment for errors is limited to the cost of that portion of the ad wherein the error occurred.
Report any errors to 800-836-2888

13 MONTH PHOTO CALENDAR only \$12.00. Call Beth at Lee Publications 518-673-0101 email bsnyder@leepub.com

CRAFT VENDOR FAIR, Spring Fling! Saturday, May 14th, 9am-3pm, Herkimer County Fairgrounds. \$1.00 admission gets you \$1.00 coupon to use that day.

★ ★ ★ ★ ★
ADVERTISERS

Get the best responses from your advertisements by including the age, condition, price and best calling hours. Also, we always recommend insertion for at least 2 issues for maximum benefits. DEADLINE for placing ads is FRIDAY at 2:00 PM- **Week Prior** to Each Friday Dated Paper. Call Peg at **1-800-836-2888** or **518-673-0111**

Announcements

HOUSE SALE: 612 Talson Park Drive, Herkimer. Fri., Sat., Sun. 9-5, April 22nd, 23rd, 24th.



THE AMIGO'S of **HERKIMER ELKS LODGE** present a Braciolo Dinner, Wednesday, April 20, 5-7pm. Pasta, tossed salad. Tickets \$10.00. Take outs available. Call 315-866-1439 reservations.

Antiques

ANTIQUES WANTED! Tin signs, old iron toys, books, guns, advertising papers WWII military items, crocks, lamps, furniture, pictures, pottery, postcards, jewelry. Anything old. Cash paid. 315-717-7295

SHOWCASE ANTIQUES-taking Estate Consignments. We'll come to you! Antiques/vintage, nothing new. Call Showcase Antiques at (315) 823-1177

ANTIQUES/FINE ART and unusual collectibles. 9200 State Route 365, Holland Patent. From Pete Rose autographs to Coca Cola ceiling fans. 315-794-9175.

Appliances

WILL REMOVE UNWANTED APPLIANCES FOR FREE

If you have unwanted refrigerators, freezers, washers, dryers, push lawn mowers, riding mowers, bikes, tillers, stoves, hotwater tanks, furnaces in cellar, home, garage.

WILL REMOVE FOR FREE
 No Labor Cost To You NO COST TO YOU

518-848-6469

Auctions

BREEDER AUCTIONS - every 2nd & 4th Sunday of the month at 11:33 am. Kings Auctions, 689 Burrows Rd., West Winfield (315)822-5221



CONSIGNMENT AUCTION every Saturday at 6:33 pm. Kings Auctions, 689 Burrows Rd., West Winfield (315)822-5221

Automotive

ATTENTION: Remanufactured starters, alternators, generator. Prompt service, Gary D. Sneath 315-826-7892

Building Materials/Supplies

INSULATION: All Types. New/ Existing Buildings. Free Estimates. Fully Insured. Call Upstate Spray Foam Insulation 315-822-5238. www.upstatesprayfoam.com

Cars, Trucks, Trailers

2001 DODGE DIESEL 4x4, extended cab, Laramie SLT, original owner, \$4700. 518-424-8455

Cars, Trucks, Trailers

- **2010 VW Jetta TDI** car, 6 speed, black with leatherette interior, 6 CD changer, pwr sunroof, alloy wheels, 112,600 miles, 1500 miles on new tires **\$10,750**
- **2002 Dodge Stratus** car, 119,000 miles, black, CD player, 2.7 V6 motor; nice, clean car **\$5,250**
- **1997 Ford 350 pickup,** 460 motor, weak trans, tool body with locks, 50% tire **\$1,800**

315-717-6937

Appliances

Cars, Trucks, Trailers

WANTED JUNK CARS, TRUCKS & VANS
PAYING \$50 & UP
7 Days a Week
315-335-3302

Collectibles

WANTED - CASH PAID: For old jewelry, old buttons, books. Dolls toys, even if broken, 1970s older. 1960s & older: Clothing. Old frames, Christmas, Halloween items. Interested in almost anything old. Shirley 315-894-9032.

Construction Services

ANTHONY MACRI

PAVING CONCRETE MASONRY

Commercial & Residential

Call With Your Needs
315-866-2733 or 315-717-3333

Cars, Trucks, Trailers



Cars, Trucks, Trailers

For Rent

ILION: Beautiful Modern upstairs apartment. Two bedroom, appliances, laundry facility, parking, no smoking/pets. Lease, references. 315-866-2552

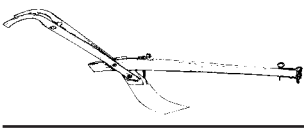

MOHAWK (Rt. #168) MOBILE HOMES IN PARK. Rental includes site/stove/refrigerator/washer/dryer/water/sewer (well & septic). Applications available on request. Take a visual tour www.crossettres.com Phone: 315-894-8557

Construction Services

For Rent

VILLAGE OF FRANKFORT Apartment-2 bedroom. No pet policy/smoke free property. Applications available on request. Take a visual tour www.crossettres.com Phone 315-894-8557

MOHAWK: New downstairs one bedroom apartment. Utilities included. No Pets. Non- Smoking. Security and References. 315-866-6588

For Sale

NEED BUSINESS CARDS? Full color glossy, heavy stock. 250 (\$45.00); 500 (\$60.00); 1,000 (\$75.00). Call Beth at Lee Publications 518-673-0101 or bsnyder@leepub.com

Farm Market Items

DAMIN FARM

Home Raised BEEF
5 VARIETIES SAUERKRAUT
Frozen BROCCOLI
CORN & CAULIFLOWER
 8075 St. Hwy 5, St. Johnsville
518-568-2643



Furniture

NEW FURNITURE - 5 deliveries just arrived, recliners, living room sets, coffee & end tables, kitchen & dining room tables and mattresses. Store hours 9-5 pm, Mon.*Wed.*Thurs.*Fri. & Sat. King's, 689 Burrows Rd., West Winfield, NY. (315)822-5221

Country Editor

**PO Box 121, 6113 State Hwy. 5
Palatine Bridge, NY 13428
800-836-2888 • Fax: 518-673-2381
classified@leepub.com**

Furniture

SOLID BLONDE dining room table with 6 padded chairs. 3½ feet wide 5½ feet long. Will seat 8 comfortably, \$150. 315-866-7013. 9am to 9pm.

Garage Sales

MOVING SALE: April 30-May 1st. 9West Monroe St., Little Falls, N.Y. Furniture, household items, tools, odds/ends. 10AM-4PM.

MOVING SALE: April 23 & 24, 9-4pm. Bedroom dresser set and bed, assorted dishes, table with 3 chairs, extra small tables, lamps, knick knacks, milk glass, tools, table saw, CD's, 19in TV, Christmas ornaments, and miscellaneous items. 219 Protection Ave, Herkimer NY.

Help Wanted

NEEDED NOW! 16 people. Full & part-time work. Sales, display & management positions. 315-985-9229

Lawn & Garden

MPG MOTORS SERVICE - REPAIR
Small Engine Powered Lawn-Garden-Equipment
Senior's Discount
25 Yrs Experience
292 Caldwell Rd., Frankfort, NY
315-219-3075

Legal Services

BANKRUPTCY, Uncontested Divorce, Family Court, Closings, Traffic; Attorney Fee \$525.00. Richard Kaplan 315-724-1850

Livestock For Sale

LAMBS, KIDS & PIGS, three months to one year. Reasonably priced. Pickup only. 315-717-8201

Magnets

BUSINESS CARD MAGNETS only \$75.00 for 250. Free Shipping. Please allow 7-10 business days for delivery. Call Beth at Lee Publications 518-673-0101 or bsnyder@leepub.com

Miscellaneous

STAG PARTY TICKETS. Free Shipping. Call Beth at Lee Publications 518-673-3237 or 518-673-0101 or bsnyder@leepub.com

Real Estate For Sale

FOR SALE BY OWNER
20 Mins from Marcy, Great for NANO people



2600 Sq. Ft. Ranch Style Home with 2 stall attached finished garage. 4 bedrooms, 3 full baths, fireplace, some appliances, hot water baseboard heat/central air, granite countertops, tile floors along with carpet, fully finished basement with kitchen and in-law apartment, heated pool and patio area, great school district.

Town of Frankfort
Call for more information or appointment to see:
(315) 527-1105 Tom

Real Estate For Sale

LAND BARGAINS: US Rte 20, Schoharie Co. 95.7 acres, \$140,000; NYS Rt. 30, Fulton Co. 33.4 acres woods, \$85,000; NYS Rt. 205, Otsego Co. 2.7 acres, views, \$23,000. Owner financing. www.helderbergrealty.com 518-861-6541, 518-256-6344

Recreational Vehicles & Motor Homes

1995 SAFARI & TITAL RV. Green & gray, 36' long, 17,500 lbs., 13,000 miles, 6 cyl. Asking \$20,000. Towing pkg kit estimated at \$2,000. Good condition inside & out. For appt. call 518-495-7489

Rentals

RENTALS: Mini Excavators, Track Loaders, Compact TLB & more. Call Randall Implements, Rt. 5S, Fultonville 518-853-4500

Services Offered

YARD WORK w/your equipment; 1st floor window cleaning; cellars cleaned. 315-601-6791

PHOTO CALENDARS now available right here at Lee Publications. 6113 State Hwy. 5, Palatine Bridge, NY 518-673-3237. Choose up to 24 photos. Only \$12.00 for digital photos and \$15.00 if we scan them.

MAN WITH A PICKUP TRUCK: Clean-outs, small moves, Spring leaf clean-ups. 315-982-9302, 315-542-2056

Real Estate For Sale

Services Offered

J & J HOME MAINTENANCE: Masonry, Painting, Chimney Repair, Stucco Ceiling Repair, Lawn Maintenance, Pressure Washing, Tree Removal, Driveway Sealing, Snow Removal. 315-868-1110 or 315-868-0059

Tires & Tire Repair Service

USED TIRE SALE: Huge Inventory, mounting & balancing FREE. No appointment necessary! Save money call Auto World, 534 North Perry Street, Johnstown 12095 518-762-7555

Trucks

FOR SALE: 1994 GMC/Isuzu-W2 commercial welding truck 4cyl turbo diesel, 105,000 miles, includes Miller Bobcat welder/ generator, all tools, oxy-lact. hoses and gauges vise, \$22,000. Call 315-895-4416.

Wanted

WANTED - old water colors, oils, vintage clothing, bottles, traps, Adirondack furniture and frames. Contact Showcase Antiques at (315)823-1177

WANTED - Lanterns, lamps, gas lighting, primitive cupboards, crocks, jugs and advertising crates. Call Showcase Antiques at (315) 823-1177

Wanted

NEED LOCAL CRAFTS OR PRODUCTS for camp ground store, for take home gifts. Call 315-429-3650

WANTED - signs, old hunting, fishing items, furniture, porch chairs, barrels and 19th century stuff. Call Showcase Antiques at (315) 823-1177

Wood For Sale

FOR SALE: Firewood, will load your truck or trailer. Also in totes. 315-823-1504

Calendar of Events

COUNTRY EDITOR

NOTE: Calendar entries must arrive at the Country Editor's office by Thursday a week before our Friday publication date for them to be included in the calendar of events. Send events to Lee Publications c/o Country Editor, 6113 State Highway 5, or PO Box 121, Palatine Bridge, NY 13428 or e-mail to: kkelly@leepub.com.

Apr 16

An Evening of Jazz with Joe Magnarelli

The Other Side, 2011 Genesee Street, Utica. Tickets \$15 adult, \$8 student. To reserve call 315-735-4825, email kodomenico@verizon.net or drop by Café Domenico.

Apr 20

"The Utica Peregrine Falcon Experience"

The Other Side, 2011 Genesee Street, Utica. 7 pm. Free to the public. For information contact Kim Domenico at 315-735-4285 or email kodomenico@verizon.net.

Apr 23

H.A.L.O.'s Annual Spring Trash and Treasure Sale

Herkimer Polish Club, 319 S. Washington Street. 9 am-4 pm. If you would like to donate to the sale, you can drop off items at the Polish Club on Apr. 22 anytime after Noon. For more information call Debbie at 866-8608 or Faye at 823-0239.

Apr 27

Rabies Clinic

Dolgeville Fire Department, 20 S. Helmer Ave., Dolgeville. 5:30-7 pm. Pre-register at www.herkimer-county.org. A \$5 donation per pet is suggested to defray costs.

May 6 - 7

Annual Spring Rummage Sale

Dolgeville United Methodist Church, Shulenburg Fellowship Hall.

- May 6, 9 am-4 pm.
- May 7, 9 am-Noon.

For more information, call 429-7381.

May 6 - 28

Nature Reseen

The Other Side Gallery, 2011 Genesee St., Utica. There will be an opening reception on May 6 from 6-9 pm. Refreshments served. Gallery hours are Thursdays from 5-7 pm and Saturdays from 11 am-2 pm. For information contact Kim Domenico at 315 735-4825 or kodomenico@Verizon.net.

May 7

Chicken Bar-B-Que

Stratford United Methodist Church, 1511 State Route 29A, Stratford. 3:30 pm. Dining room and take-outs, Adult \$9, Child \$4. Chicken, scalloped potatoes, rolls, beans/mushroom sauce, applesauce, pie. For more information call 429-7058.

CLIP & SEND

MAIL OR CALL



Country Editor

PO Box 121, Palatine Bridge, NY 13428 Ph: 518-673-3011 OR 800-836-2888

\$4.00/\$.10 each additional per week

Deadline Friday 2pm

Fill Out This Form OR

Call Us To Place Your Reader Ad

• CLASSIFIED READER AD FORM •

Today's Date _____ # of Weeks to Run _____ Starting Issue Date (Friday Date) _____

COPY: (First 14 words \$4.00, each additional word 10c, phone number counts as one word)

_____	_____	_____	_____	_____
_____	_____	_____	_____	_____
_____	_____	_____	_____	_____
_____	_____	_____	_____	_____
_____	_____	_____	_____	_____
_____	_____	_____	_____	_____
_____	_____	_____	_____	_____
_____	_____	_____	_____	_____
_____	_____	_____	_____	_____
_____	_____	_____	_____	_____

Name (Print): _____

Farm/Company Name: _____

Street: _____ County: _____

City: _____ State: _____ Zip: _____

Phone #: _____ Fax #: _____ Cell #: _____

Email Address: _____

Payment Method: Check/Money Order American Express Discover Visa MC

Card #: _____ Exp. Date: _____ MM/YY

* (REQ.) Card Security Code # _____

Name on Credit Card (print): _____

Signature: _____ Today's Date: _____

Amount Paid: _____

Ph: 518-673-3011 or 800-836-2888 • Fax: 518-673-2381 • Email: classified@leepub.com

Mail: Country Editor, PO Box 121, Palatine Bridge, NY 13428

Collecting

by Larry Cox
Ruby Glass

Q: I have a 50-piece set of ruby glass. Several years ago, I was offered \$75 per glass, but I want to sell the entire set. Any suggestions? -- Marilyn, Sonoma, Calif.

A: Ruby glass is a flashed glass, deeply red in color, and was manufactured by numerous companies beginning during the 1890s and continuing through the 1940s. Although it is sometimes confused with red carnival glass, it is made differently and not the same. Values are tricky. It might be a good idea to consult the numerous price guides available and monitor ruby glass prices on eBay.

Another suggestion is to contact a good appraiser. Although you will pay a nominal fee, you will get an expert's opinion of what your collection is worth.

Q: We have a collection of 78-rpm and LP recordings, mostly classical. Could you provide me with the names of buyers? -- Janice, via e-mail

A: I get questions about older recordings at least a dozen times a month, and my answer is always the same: Unless you have real rarities, there is little market for older recordings. I contacted used record dealers in Los Angeles, St. Louis, Dallas and New York, and I was told that it was difficult, if not impossible, to sell classical recordings in the secondary marketplace. You might consider donating your collection

to a charity.

Q: I have a series of 12 postcards that were printed to promote the 1939 New York World's Fair. I have been offered \$100, but I do not feel that is enough. -- Josie, Ormond Beach, Florida

A: According to three collectors I consulted, postcards from the 1939 World's Fair are fairly common. Your postcards are probably worth between \$2.50 and \$5 each. If you have been offered \$100 for the set, my advice is to take the money and run.

Q: I have six vintage irons, all pre-1900. Whom can I contact about them? -- Betty, Shreveport, Louisiana

A: David Irons (yes, that's his real name) is an expert and can help you determine the value of your irons. His contact information is dave@iron-santiques.com; 223 Covered Bridge Road, Northampton, PA 18067; 610-262-9335.

(c) 2016 King Features Synd., Inc.

LEE
 Family Owned Since 1953



GMC
 New & Used Sales
 St. Rt. 12, Boonville
 www.leepbg.com

Over 60 Years in Business
Where You Always Deal With An Owner
 (315) 942-2911 • (315) 942-5115

Ladies Golf Clinic
 6 Sessions Only \$99
 Begins April 27th
GOLF LESSONS
 By Mark Lane
 Head PGA Professional
 at Mohawk Valley Country Club
518-844-4558
 "I keep the rust off your swing"



Owner Dan Decola Welcomes You To
ADIRONDACK MOTORS



896-2144
General Auto Repairs & Sales
 100 MILL STREET, BARNEVELD • OPEN MON-FRI 8AM-5PM

Barney's Angels
 Small Dog Sitters Frankfort
Only \$15.00 Per Night
 ★ Home Environment
 ★ Friendly & Spacious
 ★ Clean ★ Safe
315-525-3330
 ★ Daily Facebook Dog Video's ★
 Check Us Out On FACEBOOK

BOARDING & KENNEL SERVICES



COMMERCIAL RESIDENTIAL

- Paving • Excavation
- Seal Coating
- Concrete
- Ponds + Sight Clearing
- Septic Systems

NEW HOME DEVELOPMENT



ZIELINSKI'S ASPHALT INC.
 Office 315-306-4057
 Kevin 315-725-8885 Nick 315-725-0368



Gold, Silver & Coins

Looking To Buy
 • FIREARMS •

Need Quick Cash?
 (315) 985-9024

\$20 OFF
 Any Purchase of \$99 or More
 Offer Expires 5/31/16

HOT SWAPS

120 West Albany St. Herkimer, NY
 Electronics • Tools • DVDs • & Anything Of Value



WE NOW OFFER RENT-TO-OWN OPTIONS FOR AS LOW AS \$57.00 PER MONTH

Stop in and talk to us about financing your new custom built shed!



OUTDOOR FURNITURE **GIFT SHOP**
STORAGE SHEDS

COMPARE OUR QUALITY AND PRICING
 We think you'll be glad you did.

Yoder's Quality Sheds LLC
 Located at 278 Atswell Rd., Richfield Springs, NY
315-858-0841
 Mon-Fri 8am-5pm • Sat 8am-3pm • CLOSED SUNDAY

SWAP & SHOP

Hosted By Shu-Maker Mountain Climbers

★ New ★ Used ★ Vintage
SWAP MEET

Snowmobile, ATV, Motorcycle, Trailer, Parts, Etc.
 Free Vending... Free Entry
 Show Sleds Welcome... No Judging

FREE AUCTION AT THE END OF THE DAY
 Food Provided by Shu-Maker Mountain Climbers

BRING WHAT YOU HAVE... FIND WHAT YOU NEED

Saturday, April 23, 2016
8:00am - 3:00pm

NEW LOCATION:
 State Rt 5S, Little Falls, NY
 Just off NY State Thruway Exit 29A - Little Falls
 GPS Address: 130 Old Herkimer Road, Little Falls, NY 13365



Did you know?

The excitement of driving a new car off of the lot extends beyond the thrill

of having a new set of wheels to show off. Some people just love the smell

of a new car. But while that aroma may be pleasant to the olfactory sens-

es, it may be wise to eliminate the smell as soon as possible. According to a 2012 study from the non-profit Ecology Center and HealthyStuff.org, that "new car smell" may include toxic fumes from chemicals used to create the car's interior. There are some indications that the smell is generated

from more than 50 volatile organic compounds, or VOCs, that are off gassing in a relatively confined space. While the potential dangers of breathing in all of these compounds continue to be studied, the flame-retardants and plastics used in cars have been linked to illnesses

when they have been used in other applications. To speed up the process of removing VOCs from a car, open all of the windows and let it sit in the hot sun. Also, purchasing a vehicle that has been sitting on the lot for a while may mean some of the chemicals have dissipated.

**CARS WANTED
DEAD OR ALIVE!**

(PICK UP AVAILABLE)



**WE PAY
YOU \$\$\$**

CALL 315-794-5498

ACCENT

BROKERAGE INC. www.accentbrokerage.com

Rebecca Smith - R.E. Broker
 Kelly Jackson - R.E. Salesperson
 James Caiola - R.E. Salesperson
 Lorene Prenderville - R.E. Salesperson
 Erin Dibble - R.E. Salesperson

Phone: 315-219-5990 Fax: 315-219-5991



<p>JUST LISTED 810 Bellinger Ave, Herkimer  - Very lovely 2 story home in a great village location. Has 3BRs, 1.5 baths, LR, formal dining room, kitchen, and basement laundry. Great location, attached garage, appliances. Welcome Home!</p>	<p>JUST LISTED 10 Orchard St, Mohawk  Nice 3 family with separate heat and electric. Two of the apartments are 1BR/1 bath, one 2BR, 1 bath apartment. Coin-op washer and dryer.</p>
<p>JUST LISTED 50 Cottage St, Ilion  Looking for an investment? This affordable Ilion 2 family home has 2BR, 1 bath apartments. Separate heat and electric, nice rents.</p>	<p>JUST LISTED 144 W North St, Ilion  Affordable village 2 family with decent rents and separate heat and electric. Call for your appointment today.</p>

OPEN HOUSE SATURDAY APRIL 16TH
10:00 TO 11:00AM
416 & 416 1/2 N Prospect St, Herkimer

 2 for the price of 1! Front colonial is overflowing with charm. Gleaming hardwood floors, beautiful windows, nice large entrance hall leading to the grand staircase, LR w fireplace, DR w beautiful built in cabinets, 4BRs, 1 1/2 bath baths, 2nd floor laundry & so much more. Home is a package deal w a beautiful and tastefully updated 2BR, 1 bath house in the back. Don't miss out!

OPEN HOUSES
Saturday April 16, 2016

<p>10 to 11am 416 & 416 1/2 N Prospect St, Herkimer 119 N Bellinger St, Herkimer 50 W Shore Dr, Stratford</p>	<p>1 to 2pm 45 Walnut St, Mohawk 8 Columbia Circle, Mohawk 2150 State Route 28, Mohawk</p>
<p>11:30am to 12:30pm 612 Talson Park Dr, Herkimer 629 Park Lane Dr, Herkimer 810 Bellinger Ave, Herkimer</p>	<p>2:30 - 3:30pm 142 Prospect Ave, Ilion 19 Buchanan St, Ilion 37 Woodside Ave, Little Falls</p>

Got PROPANE?

Free Hook-up • NO Hidden Fees
 Lock-In Pricing

- Senior Discount • Cash Discount •
- Budget & Prepay Plans • HEAP •
- Multiple Product Discount •
- Service Contracts • 24 Hour Sales & Service •

Locally Owned Company Delivering...



- PROPANE
- HEATING OIL
- DIESEL
- KEROSENE
- GASOLINE

Harbor Point

ENERGY PRODUCTS

132 East Main St., Frankfort, NY
315-894-4328 (HEAT) • 315-732-4328 (HEAT)
 53 West Main St., St. Johnsville, NY
518-568-5228
HarborpointEnergyProducts.com

OPEN BOWLING DAILY
 Bowling Birthday Parties
 COSMIC BOWLING
 Fri-Sat Nights 9:30-12:00
 Family Days
 Sat. 9:30am-Close • Sun. 1:00pm-Close



STATE BOWL
 17 E. State Street, Ilion • 315-894-4862
www.statebowlingcenter.com

Ilion Farmer's Market
 proudly presents
**Clapsaddle Farm's Annual
 Maple Syrup Weekends
 April 9TH & April 16TH**

Maple Demonstrations: Bottling, Tapping
Pancake Breakfast Noon-5PM
 served Clapsaddle Farm
 Rt. 51, 437 Otsego St., Ilion, NY
 894-4660



CAROLE & RAY PIAZZA
 (315) 429-3352

MILITARY ROAD
 SALISBURY, NY 13454



Journey's End
 Antiques & Collectibles

Open by Chance or Appointment



HUGE CAN'T-MISS SAVINGS!



STK# P1451A • 24,296 MILES

2014 FORD FIESTA
\$8,497

PLUS TAXES, TAGS AND DMV FEES!



STK# 6125A • 86,161 MILES

2008 NISSAN ALTIMA
\$8,988

PLUS TAXES, TAGS AND DMV FEES!



STK# R1510 • 46,898 MILES • PRIOR RENTAL

2014 FORD FOCUS
\$9,689

PLUS TAXES, TAGS AND DMV FEES!



STK# 5488B • 57,365 MILES

2012 NISSAN SENTRA
\$9,777

PLUS TAXES, TAGS AND DMV FEES!



STK# R1403A • 45,027 MILES

2012 HYUNDAI® ACCENT
\$9,888

PLUS TAXES, TAGS AND DMV FEES!



STK# 5567A • 65,200 MILES

2009 CHEVY MALIBU
\$10,777

PLUS TAXES, TAGS AND DMV FEES!



STK# 5734B • 32,300 MILES

2013 KIA OPTIMA
\$14,699

PLUS TAXES, TAGS AND DMV FEES!



STK# 4891B • 43,901 MILES

2012 JEEP PATRIOT
\$14,888

PLUS TAXES, TAGS AND DMV FEES!



STK# 6297A • 28,326 MILES

2013 DODGE GRAND CARAVAN
\$16,995

PLUS TAXES, TAGS AND DMV FEES!



STK# 6070A • 46,166 MILES

2011 FORD F-150
\$24,991

PLUS TAXES, TAGS AND DMV FEES!



STK# 5669A • 46,810 MILES

2012 FORD F-150
\$26,288

PLUS TAXES, TAGS AND DMV FEES!



STK# P1456 • 49,722 MILES

2013 FORD EXPLORER
\$28,888

PLUS TAXES, TAGS AND DMV FEES!



STK# 6038A • 5,348 MILES

2015 RAM 1500
\$29,555

PLUS TAXES, TAGS AND DMV FEES!



STK# 6135A • 48,901 MILES

2012 FORD F-150
\$29,777

PLUS TAXES, TAGS AND DMV FEES!



STK# P1533 • 44,602 MILES

2011 FORD F-150
\$29,891

PLUS TAXES, TAGS AND DMV FEES!



STK# P1534 • 24,635 MILES

2013 FORD F-150
\$29,991

PLUS TAXES, TAGS AND DMV FEES!



STK# 6002A • 34,189 MILES

2014 FORD F-150
\$30,488

PLUS TAXES, TAGS AND DMV FEES!



STK# 6014A • 8,881 MILES

2014 FORD F-150
\$31,555

PLUS TAXES, TAGS AND DMV FEES!



STK# 6078A • 14,937 MILES

2008 FORD F-250SD
\$32,899

PLUS TAXES, TAGS AND DMV FEES!



STK# 6006A • 6,439 MILES

2015 GMC SIERRA 1500
\$38,888

PLUS TAXES, TAGS AND DMV FEES!

**NEED FINANCING? BILLY MAY BE ABLE TO HELP.
APPLY FOR PRE-APPROVAL AT: GETHUGEcredit.com**



FUCCILLO FORD OF NELLISTON



6500 NY-5 • FORT PLAIN, NY 13339 • 888-655-9420 • HUGEPLEX.COM HOURS: SALES MON.-THURS. 9-7, FRI.-SAT. 8-6, SUN. 10-5 SERVICE MON.-FRI. 9-5
PRIOR SALES EXCLUDED. SEE DEALER FOR COMPLETE DETAILS. PRICING AVAILABLE THROUGH APRIL 30, 2016.