

THE Original Valley Pennysaver

Volume 6
Number 40

Serving the Homes of the Mohawk Valley
Delivered Weekly by the U.S. Postal Service

April 16, 2016

The
MATTRESS AND FURNITURE
SUPER STORE

See Our Full Page Ad on Page 3

75 Briggs St., Johnstown
(518) 762-1807

IT'S SPRING!



2008

Volkswagon Beetle

SE Convertible, Auto, Leather,
58,375 miles

\$11,888



2013

Volkswagon Beetle

Convertible, Auto, Leather, 9,396 Miles

\$19,999

MAIN MOTORCAR
JOHNSTOWN, NEW YORK

This is what
we do!

CHRYSLER
DODGE
Jeep
RAM

762-HEMI

Sales Hours:

Mon-Thurs 9-7; Fri 9-6; Sat 9-2

Service & Parts: Mon - Fri 8-5

224 W. Main St., Johnstown, NY 12095

www.mainmotorcar.com

Tax & title fees extra.

PRRT STD
ECRWS
U.S. POSTAGE
PAID
EDDM RETAIL

*****ECRWSSEDDM****

Local
Postal Customer



Licensed Real Estate Broker
Laurie Weingart
518-673-2820



Call the Pros

59 W. Main St., Canajoharie 518-673-2820 www.krutz-properties.com

RESIDENTIAL - COMMERCIAL - FARMS - INVESTMENTS - ACREAGE

CALL THE PROS AT KRUTZ PROPERTIES LLC

- Your Hometown Realtors -

Krutz Properties is #1 per Capital District MLS for property SOLD in Montgomery County!

FEATURED LISTINGS OF THE WEEK



512: **NEW LISTING!!!** 16 Austin Street, **AMSTERDAM:**
Beautiful well cared for home with a new roof, updated windows and kitchen. Formal dining room, spacious living room and new half bath on 1st floor. Finished basement with a recreational room. Features hardwood floors, tile flooring and a back enclosed porch. Back deck and a nice yard. Nice residential street. **Asking \$124,900**

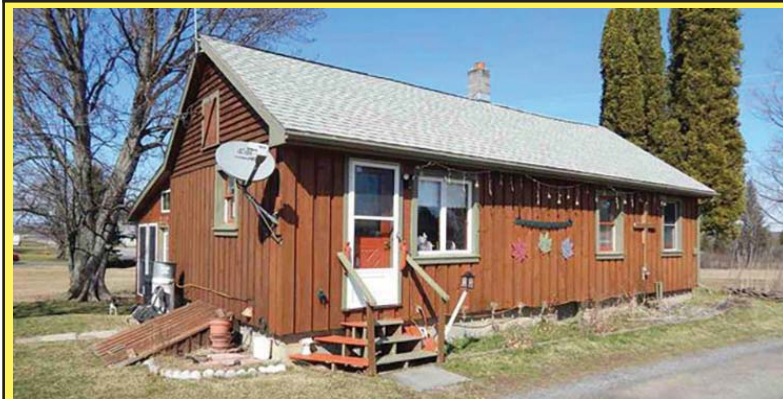

605: **NEW LISTING!!!** 6194 Carlisle Road, **SPRAKERS:**
Affordable country home that has been very well maintained by the current owner. The location offers privacy and beautiful sunrises and sunsets. The garage/barn is great for storing all of your toys or homesteading. Easy commute to the Capital District and/or Cobleskill.

Asking \$99,900



008: 63 Schultze Street, **CANAJOHARIE:** Nice ranch style home located on a quiet dead-end street. Asphalt roof and vinyl siding installed 6 years ago. The home is very sound, but needs some cosmetic work inside. Located 2 blocks from the Elementary School. Walkout basement, one car attached garage with entry into the kitchen. **Asking \$95,000**



012: 50 Third Ave., **CANAJOHARIE:** This house is doubled brick walled, no brick veneer with fully insulated air space from foundation to attic. The foundation is poured concrete and is dry and has a laundry room. The floors are hardwood under carpet throughout the home. On the second floor, there is a spacious bedroom with a master bath. The house has substantial storage space. There is a new furnace. There are two open porches front and back with slate tiles and a small enclosed porch with a full sink. Fully functional fireplace. **Asking \$137,500**



014: 26 Center Street, **PALATINE BRIDGE:** This home has been totally remodeled from top to bottom with beautiful hardwood floors through-out. Large bedroom on first floor that could be made into two bedrooms or converted into a master bathroom. A nice open space on the second floor that can be a family room or kids play area. Located on a dead end street with a decent size backyard for the kids to play. There is a new roof, new furnace and hot water heater. Brand new kitchen with granite countertops. The house has plenty of natural light. **Asking \$135,000**



507B: **NEW LISTING!!!** 3 Third Ave., **CANAJOHARIE:** Bungalow style home with hardwood floors, enclosed front porch and a back deck. Formal dining room, new furnace and hot water heater. Walking distance to the schools. Taxes based on old assessment. **Asking \$59,900**



673: 1060 Stone Arabia Road, **FORT PLAIN:** Hard to find very well updated ranch style home in the Country! Hard to find one like this, so don't miss a chance to view it. The beautiful custom cabinetry in the kitchen matches seamlessly with the ranch Country appeal of the rest of this home. Plenty of privacy without too much acreage to maintain. Best of both worlds! **Asking \$129,000**



951: 262 Goldman Road, **SPRAKERS:** Let Mother Nature pay your electric bill at this country gem. A Solar Intergraded Electrical System provides your power. A nice 14 x 30 Mobile home with a 10 x 15 enclosed porch is complimented by a 30 x 40 barn with a full Studio Loft Apartment. The barn has 220 amp for welding plus an office. The large pond in the middle of the property brings it all together. Lots of flowers and plants dot the property. Plenty of room to roam for the kids and critters on almost 8 private acres. **Asking \$149,000**

THE PLACE IS *HERE*. THE TIME IS *NOW*. THE SAVINGS ARE *HUGE!*



2015 CHRYSLER 200 LIMITED

STK# R5652 • 32,773 MILES • PRIOR RENTAL

\$15,000
PLUS TAX, TAGS & DMV FEES



2014 JEEP PATRIOT SPORT 4X4

STK# R5583 • 26,799 MILES • PRIOR RENTAL

\$17,000
PLUS TAX, TAGS & DMV FEES



2014 JEEP COMPASS SPORT 4X4

STK# R5330 • 16,381 MILES • PRIOR RENTAL

\$18,000
PLUS TAX, TAGS & DMV FEES



2014 DODGE GRAND CARAVAN SXT

STK# R5417 • 35,425 MILES • PRIOR RENTAL

\$18,000
PLUS TAX, TAGS & DMV FEES



2014 DODGE CHARGER SE

STK# R5261 • 17,333 MILES • PRIOR RENTAL

\$19,000
PLUS TAX, TAGS & DMV FEES



2014 CHRYSLER TOWN AND COUNTRY TOURING

STK# R4718 • 30,841 MILES • PRIOR RENTAL

\$20,000
PLUS TAX, TAGS & DMV FEES



2015 JEEP GRAND CHEROKEE LIMITED 4X4

STK# P5681 • 54,352 MILES

\$27,000
PLUS TAX, TAGS & DMV FEES



2015 JEEP CHEROKEE TRAILHAWK 4X4

STK# P5561 • 9,544 MILES

\$29,000
PLUS TAX, TAGS & DMV FEES



NEED FINANCING? BILLY MAY BE ABLE TO HELP. APPLY FOR PRE-APPROVAL AT: GETHUGEcredit.com



FUCCILLO CHRYSLER, DODGE, JEEP, RAM OF NELLISTON

6460 STATE HIGHWAY 5 • NELLISTON, NY • 518-993-5555 • HUGEplex.com

HOURS: SALES MON.-THURS. 9-7, FRI.-SAT. 8-6, SUN. 10-5 SERVICE MON.-FRI. 9-5

PRIOR SALES EXCLUDED. SEE DEALER FOR COMPLETE DETAILS. PRICING AVAILABLE FROM APRIL 1, 2016 THROUGH APRIL 30, 2016.





SAVE BIG AT

The
MATTRESS AND FURNITURE
SUPER STORE



COUPON
\$50 OFF
Recliners
With This Coupon
Cannot be combined



COUPON
\$100 OFF
Any Sofa
With This Coupon
Cannot be combined

COUPON
2 FREE Pillows
With Purchase Of
Mattress Set
With This Coupon
Cannot be combined

**We Beat
Competitor's
Prices!**

FOR A LIMITED TIME!
\$100⁰⁰ OFF
all Queen Mattress Sets
STARTING AT \$599⁹⁹!

FOR A LIMITED TIME!
RECEIVE A FREE NIGHTSTAND
With the
purchase of any
5 piece
bedroom set!



SERTA & KING COIL
MATTRESSES
Starting at:



TWIN \$199 • FULL \$269
QUEEN \$299 • KING \$499

The
MATTRESS AND FURNITURE
SUPER STORE

75 Briggs St.
Johnstown
(518) 762-1807



www.superstorejohnstown.com



Free Delivery Up To 40 Miles • FREE LAYAWAY
OPEN 7 DAYS A WEEK: Mon-Thurs 9-7; Fri 9-8; Sat 9-6; Sun 10-4

ST. JOHNSVILLE 25 W. Main St. Prices Good
 St. Johnsville, NY 13452 Sat. 4/16 -
 Fri. 4/22/16

LITTLE m MARKET

COUPON
BEST SUBS IN THE VALLEY
\$1⁰⁰ OFF A LARGE SUB
DRY CLEANING
 Drop Off/ Pick Up on Monday!!!

Chicken Thighs or Drumsticks



89¢ Lb.

Boneless Sirloin Steaks



\$4⁹⁹ Lb.

Boneless Pork Chops



\$2⁶⁹ Lb.

Split Chicken Breast



\$1⁷⁹ Lb.

12-24 Oz. Bob Evans Dinner Sides



\$3²⁹

Johnsonville Breakfast Sausage Links or Patties



\$3⁹⁹ Ea.

5Lb. Red or Gold Potatoes



\$2⁹⁹

16oz. Strawberries



\$2⁹⁹

Large Sweet Onions



\$1²⁹ Lb.

Red Seedless Grapes



\$1⁹⁹ Lb.

Crystal Geyser 24pk 16.9 oz.



\$3⁹⁹

Boar's Head

Black Forest Ham \$7⁹⁹ lb.

Mild Swiss \$7⁹⁹ lb.

NOTICE TO PARENTS OF KINDERGARTEN REGISTRATION

The Canajoharie Central School District will be conducting Kindergarten Screening and Registration on Friday, May 13, 2016 and Saturday, May 14, 2016 for children entering Kindergarten in September. It will take place in the Library at the East Hill Elementary School.

New York State Education Law requires schools to screen every child entering Kindergarten in order to identify conditions which may effect his/her education. For a child to enter Kindergarten in September 2016, he or she must be at least five years old on or before December 1, 2016. Parents must bring to screening the child's birth certificate, an immunization record signed by a doctor, proof of residency and completed entrance forms.

Parents of eligible students are requested to contact Mrs. Sherri Hodge at the East Hill Elementary School at 673-6310



Published weekly on Saturday by Lee Publications
 6113 St. Hwy. 5, Palatine Bridge, NY 13428

Publisher, President
Frederick W. Lee
 V.P., General Manager
Bruce Button
 V.P., Treasurer
Janet Lee Stanley

Classified Ad Manager.....Peggy Patrei
 Controller.....Lyndsay Bock
 Managing Editor.....Joan Kark-Wren
 Production Coordinator.....Jessica Mackay
 Shop Foreman.....Harry DeLong

Ad Sales

John Snyder, Sales Manager
 518-673-0129, jsnyder@leepub.com
Kristen Lee, Sales Associate
 518-673-0100, klee@leepub.com
Mary Skinner, Sales Associate
 518-673-0130, mskinner@leepub.com
Jed Suits, Sales Associate
 518-673-0131, jsuits@leepub.com

Reader ads 518-673-0111 or 800-218-5586

Bruce Button - Corporate Sales Manager
 518-673-3011, bbutton@leepub.com
Accounting/Billing - Pauline Tripp
 518-673-0150, ptripp@leepub.com
Commercial Printing - Beth Snyder
 518-673-0101, bsnyder@leepub.com

Send all correspondence to:
 PO Box 121, Palatine Bridge, NY 13428
 Advertising e-mail: jsnyder@leepub.com
 Editorial e-mail: jkarkwren@leepub.com
 Web site: www.vpennysaver.com
 518-673-0129 Phone • 518-673-2699 Fax

We cannot GUARANTEE the return of photographs. Publisher not responsible for typographical errors. Size, style of type and locations of advertisements are left to the discretion of the publisher. The opinions expressed in this publication are not necessarily those of the publisher. We will not knowingly accept or publish advertising which is fraudulent or misleading in nature. The publisher reserves the sole right to edit, revise or reject any and all advertising with or without cause being assigned which in his judgement is unwholesome or contrary to the interest of this publication. We assume no financial responsibility for typographical errors in advertisement, but if at fault, will reprint that portion of the ad in which the error appears.

We want to hear from you!
 Send your comments & suggestions to the **Original Valley Pennysaver**
 PO Box 121, Palatine Bridge, NY 13428
 OR email jsnyder@leepub.com

FOR SALE: Set of 4 Eagles LS P225/50 R18. Fits Chrysler 200, asking \$225 OBO. Call 518-993-2111.

RAGTIME: Here we are and we're back again with our 50% Off Sale. 2 floors, 3000 sq. feet of stuff for sale, 39 Main Street, Fort Plain Thursday thru Saturday 11ish to 5pm. **CHECK IT OUT!**

We fix Snow blowers, weed eaters, lawn mowers and ALL small engines. Full Throttle LLC, 6 South Division, St. Johnsville, NY (518)568-8113

GREAT SELECTION OF BLUE decorated stoneware. Most in perfect condition. Many collector pieces. Great prices. THE GALLERY, 2 West Main Street, Saint Johnsville, NY 13452. Telephone 518-568-5121.

ROOF & FLOOR TRUSSES - fabricated for residential, commercial or agricultural construction. Call for a free quote. C.H. BURK-DORF & SON, 35 Hough St., St. Johnsville 518-568-7016

WE ARE GEARING UP FOR SPRING! Wheelbarrows, potting mixes, shovels, bow rakes are all in! Stop in to check out the selection! **Behind every project is a True Value 12 Willett St Fort Plain 993-3834**

DOES YOUR APPLIANCE NEED REPAIR? Call Koval's. Ed has over 30 years experience! (315) 867-9333

ALREADY CON-SIGNED FOR OUR SPRING AUCTION APRIL 23RD 9:00AM ARE 2 EARLY ANTIQUE BUGGIES, 1-HORSE DRAWN WAGON, 1- ONE SEATER BUGGY GREEN WHEELS, 1-SLEIGH, 1 EARLY DOCTORS BUGGY AND MORE STILL COMING, IF YOU HAVE MACHINERY AND BUGGIES TO SELL GIVE US A CALL JR'S AUCTION 518-993-4668

PACA GARDENS, 27 West Main St, Little Falls, NY stocks **Fine Alpaca Clothing.** Socks, sweaters, fur hats, scarves, gloves, mittens and much more. Alpaca is warmer than wool and softer than cashmere. 315-823-1100 M-F 10-5, Sat 10-4. Layaways available.

JR'S AUCTION IS AGAIN DOING ON SITE SPRING AUCTIONS!! WE PROVIDE COMPLETE AUCTION SERVICE FOR YOUR ON SITE AUCTION INCLUDING; ESTATES, COMPLETE FARM SALES, LIVESTOCK, FARM MACHINERY, CONTRACTOR EQUIPMENT, INDUSTRIAL, BUSINESS ASSETS, HOUSE AUCTIONS AND MORE!! GIVE US A CALL FOR A FREE QUOTE!! 518-993-4668

IN STORE SPECIAL! - Karcher G2800 OC Pressure Washer \$289-While Supplies Last! Behind every project is a True Value 12 Willett St Fort Plain NY 993-3834

HAVING PROBLEMS with your well or pump? Call The Water People - Provost Brothers! 518-868-2126

2012 HYUNDAI VELOSTER, Red, 26K, 4Cyl., Auto, AC, CD. Sale \$15,995. John C. Miller Inc (518)762-7124. www.johncmiller.com

\$75.00+ CHIMNEY/ DRYER-VENT cleaning/repairs. Stainless chimney relining, repointing, rebuilding. New chimney construction, fireplaces, inserts, new & used woodstoves. Raincaps & dampers. Insured. Free estimates. 315-542-5509

TIRES, TRACKS, HELMETS AND GOGGLES for ATV's & snow machines. We've got you covered! Full Throttle LLC, 6 South Division, St. Johnsville, NY (518)568-8113

SOLID CHERY PERIOD CHIPPENDALE 4-drawer chest in original condition. Suitable to go right into your home. Great price. THE GALLERY, 2 West Main Street, Saint Johnsville, NY 13452. Telephone 518-568-5121.

24/7/365 Shults Insurance Agency is here for you! For all of your insurance needs! 800-836-2885

CRAFTERS WANTED Fort Klock's 44th Annual Craft Fair Saturday and Sunday Sept. 10-11, 2016 Fort Klock Historic Restoration, St. Johnsville, NY Email fortklock@gmail.com for more information.

ST. JOHNSTOWN store front, 1,000 sq. ft. kitchenette, plus bathroom. All new, \$550+. 518-301-5739

THOUGHT FOR THE WEEK: "Let's Attend Church This Sunday". You and your family are welcome at Grandview Baptist Church, corner of Lydius & Washington St., Ft. Plain, NY. Sunday School 10am. Morning Worship 11am.

NEED YOUR APPLIANCE REPAIRED? Koval's has over 30 years experience and is affordable! Call (315)867-9333

MAKE our phone ring so we can return the favor!! Place your reader ad today. Only \$4.00 for the first 14 words. 518-673-3237

2008 FORD TAURUS SEL, Green, 69K, V-6, Auto, Leather. Sale \$8,495. John C. Miller Inc. 518-762-7124. www.johncmiller.com

VICTORIAN WALNUT oval white marble top table with very ornate base. Priced to sell! THE GALLERY, 2 West Main Street, Saint Johnsville, NY 13452. Telephone 518-568-5121.

2007 DODGE CALIBER R/T AWD, Blue, 76k, 4Cyl, Auto, AC, CD, Moonroof. Sale: \$7,995. John C. Miller Inc. 518-762-7124. www.johncmiller.com

NEED BUSINESS CARDS?

Full Color Glossy Heavy Stock
250 (\$45.00)
500 (\$60.00)
1,000 (\$75.00)
Call Beth at
Lee Publications
518-673-0101 or
bsnyder@leepub.com
FREE SHIPPING

HAVING A PARTY? Did you know the Canajoharie Volunteer Fire Department rents the kitchen and banquet room. For your convenience we now have an elevator. 518-673-3812

USED TIRE SALE: Huge Inventory, mounting & balancing FREE. No appointment necessary! Save money call Auto World, 534 North Perry Street, Johnstown 12095 518-762-7555

BREEDER AUCTIONS - every 2nd & 4th Sunday of the month at 11:33 am. Kings Auctions, 689 Burrows Rd., West Winfield (315)822-5221

8 FOOT TABLES & folding chairs for rent. Canajoharie Volunteer Fire Department 518-673-3812

WANTED: Fryer Oil. 518-568-3496

SUPPORT YOUR LOCAL MERCHANTS. BUY LOCAL or BYE, BYE LOCAL!

R. LOTTMAN EXCAVATING

~ SPECIALIZING IN POND CONSTRUCTION ~

Residential & Commercial Sitework including:

- Foundation, Concrete Work and Drainage
- Excavation Work
- Brush Hogging
- Septic Systems
- Land Clearing
- Gravel Sales & Delivery

Over 30 Years Experience!!

"When it comes to Heavy Equipment, Got it all!"

(518) 673-5004 • (518) 365-8444 Cell

Many Hands Make Light Work!

Village of St. Johnsville

Volunteers Needed
Many committees to choose.

For info call today!
518-568-2221

Mrs. M. LLC

LANDSCAPING & SNOWPLOWING

COMMERCIAL • RESIDENTIAL

"Family owned & operated for over 30 years"

SCHEDULE YOUR SPRING CLEAN UP NOW

- Lawn Mowing - Weekly & Bi-Weekly
- Complete Custom Landscaping & Design
- Complete Mulching Installation
- Trimming • Shrub & Tree Pruning
- Screened Top Soil • Retaining Walls
- Stone Products (Crusher Run, Sand, Colored Stone)
- Tree & Shrub Installation
- Brush Hogging • Lawn Seeding
- Excavation • Planting
- Decorative Mulch (variety of colors)
- Edging • Fall and Spring Clean ups

ACCEPTING
NEW
CUSTOMERS
FOR 2016
SEASON

CALL BRIAN
FOR FREE ESTIMATES

Owner: Patty Mabie

518-598-9116 • 518-673-5622

Free Estimates - Fully Insured
Sprakers, NY

I would like to sincerely thank everyone for the cards, food, flowers and get well wishes I received after my accident. It was greatly appreciated.



Thank You,
Linda Spencer

Enea Family
Funeral Homes
LITTLE FALLS
ST. JOHNSTOWN - DOLGEVILLE

CALL TODAY FOR THE MOST COMPETITIVE PRICES
Cremation Center
Monument Center

Kevin Enea Funeral Director
email:
kevinenea@dwmonuments.com
1-518-568-2300 OR
1-877-581-3632

At
Grandview Baptist Church
Adult Sunday School 10AM
Names of Jesus
Sunday Morning Service 11AM
The Gospel of John
Wednesday Bible Study & Prayer
6:30PM
Life's Rough Patches
All Are Invited

15 Washington St.,
Fort Plain, NY
518-993-9929
Pastor Dan West

WANTED
JUNK CARS,
TRUCKS & VANS
PAYING \$100 & UP.
7 Days a Week
315-335-3302

DAMIN FARM
Home Raised **BEEF**
5 VARIETIES
SAUERKRAUT
Frozen **BROCCOLI**
CORN & CAULIFLOWER
8075 St. Hwy 5, St. Johnsville
518-568-2643

WE PAY CASH!
for all types of, Silver
Gold & Diamond jewelry.
Gold Is At
An All-Time High
William Doerrner
& Son Jewelers
16 Canal Street, Fort Plain
(518) 993-3388

Gohde Enterprises
We have
equipment
rentals for
any size
project,
big or small
Dumpster Rentals
Now Available
Daily • Weekly • Monthly
607-264-9347
Cell: 607-287-8411

KOVAL's Major Appliance Repair knows customer satisfaction, affordable and prompt! Call (315)867-9333

Store, Office or Restaurant
FOR RENT at 29 Church St. Canajoharie
Large 16'x70' But Can Reduce Size if Needed
Will Do Some Building to Suit **\$395**
518-673-5938 - No Answer in 3 hrs 518-365-2976

Curious About Your Water Quality? Call the Expert!!!
COUNTRYMAN WATER CONDITIONING
SALES • SERVICE • RENTALS
• A Family Business Since 1956 •
Certified Water Specialist
6880 State Hwy. 5S
Fort Plain
countrymanwater@yahoo.com
518-993-2888 • 1-800-993-2824

SPRING SPECIAL
CHARLES D. STAHL
SPLIT HARDWOOD
"SPECIAL TRUCKLOAD SALES"
5+ Face Cords Delivered **\$375**
Approx. 7 1/2 Face Cords **\$495**
Approx. 11+ Face Cords **\$775**
FURNACE CHUNK WOOD
Approx 11+ Face Cords **\$695**
Delivered (may include extra delivery charges)
HEAP ACCEPTED
697 Snells Bush Rd.,
Little Falls, NY 13365
315-823-1982

POHLIG ENTERPRISES INC.
LOVENHEIM'S
634-636 E. MAIN ST., LITTLE FALLS • (315) 823-2640
"Over 50 Years Combined Experience
in the Decorating Business!"
Aura, Regal Select & Ben
Benjamin Moore Paints & Primers
• Wallcoverings (in stock and custom orders)
• Window Treatments • Mattresses • Sundries
• Floor Coverings - Carpet, Sheet Vinyl, Cork Floors & More
Benjamin Moore • Armstrong • Kirsch • SPRING AIR
"Customer Service is Our Priority!"
All Major Credit Cards Accepted
Hrs: Mon., Tues., Wed., Fri. 8-5; Thurs. 8-6; Sat. 9-3; Sun. Closed

LAND BARGAINS: US Rte. 20, Schoharie Co. 95.7 acres, \$140,000; NYS Rt. 30, Fulton Co. 33.4 acres woods, \$85,000; NYS Rt. 205 Otsego Co., 2.7 acres, views, \$23,000. Owner financing. 518-861-6541, 518-256-6344 www.helderbergrealty.com

RUBBER STAMPS self inking. All sizes. Call Beth at Lee Publications. 518-673-0101

FOR RENT ST. JOHNSSVILLE. Newly remodeled, washer and dryer, parking, \$600 with heat. 518-848-1299

GREAT SELECTION OF 14K and 18k yellow or white gold diamond wedding sets. One-of-a-kind sets. Special and unusual designs available at wholesale prices. THE GALLERY, 2 West Main Street, Saint Johnsville, NY 13452. Telephone 518-568-5121.

2004 CHEVY VENTURE, Blue, 82K, V-6, Auto, AC, PW, PL. Sale: \$4,995. John C. Miller, Inc. 518-762-7124. www.johncmiller.com.

NEED PIPE? We can supply you with perf. & solid drainage pipe 4" x 100', 4" x 250' and 6" x 100'. Smoothwall pipe in 4" x 10' lengths. Fittings also available. Schedule 40 in 1 1/2", 2", 3" & 4" x 10' pipe & fittings. Culvert Pipe - 8" thru 24" x 20'. C.H. Burkdorf & Son, 35 Hough St., St. Johnsville 518-568-7016

KOVAL'S APPLIANCE repair is affordable and fast. Call anytime (315) 867-9333.

BREEDER AUCTION - Sunday April 10th & 24th at 11:33 am. Kings Auctions, 689 Burrows Rd., West Winfield (315)822-5221.

WANTED - Lanterns, lamps, gas lighting, primitive cupboards, crocks, jugs and advertising crates. Call Showcase Antiques at (315) 823-1177

FOR SALE: VIEW-POINT VINYL REPLACEMENT WINDOWS which are durable, low maintenance and ENERGY STAR APPROVED with lifetime warranty against glass breakage. C.H. BURKDORF & SON, 35 Hough St., St. Johnsville 518-568-7016

SELF INKING STAMP - Great for Raffle Tickets. \$20.00+ tax. Call Beth at Lee Newspapers Inc. 518-673-0101

GOT COLD FEET? - We have the warmest socks for you. Alpaca Extreme Boot Socks and Alpaca Survival Socks. Alpaca is warmer than wool and keeps your feet toasty warm. These are a must for anyone working outdoors in cold weather. We guarantee you will love them. Paca Gardens, 27 West Main St, Little Falls. 315-823-1100 M-F 10-5, Sat 10-4. Layaways available.

ST JOHNSSVILLE house for rent, (5) bedroom, (2) full bath, (3) fire places, circular driveway, large yard. Security and references required. \$875 a month. Please call 315-867-3931 or 518-568-2776.

CRAFT VENDOR FAIR, Spring Fling! Saturday, May 14th, 9am-3pm, Herkimer County Fairgrounds. \$1.00 admission gets you \$1.00 coupon to use that day.

KOVAL's Major Appliance Repair has over 30 years experience and is affordable. Call (315)867-9333

LET US HELP you get rid of your unwanted stuff. Place a reader ad today. Only \$4.00 for the 1st 14 words. Call 518-673-3011

24/7/365 Shults Insurance Agency Is here for you! For all of your Insurance needs! 800-836-2885

FOOD AUCTION THE FIRST WEDNESDAY OF EVERY MONTH AT JR'S AUCTION 7403 ST HWY 5 ST JOHNSSVILLE, NY 518-993-4668

PACA GARDENS has the Finest Alpaca Products available. Alpaca is warmer than wool, softer than cashmere and hypo-allergenic. Alpaca products make great gifts. Layaways available. 27 West Main St, Little Falls. 315-823-1100 M-F 10-5, Sat 10-4.

HATE THOSE STAINS caused by algae, mold, mildew, moss & lichen. Get rid of them by USING SPRAY & FORGET with no rinsing needed. Works on gravestone's, roofs, decks, foundations, etc. It really works!! C.H. BURKDORF & SON, 35 Hough St., St. Johnsville 518-568-7016

2010 CHEVY IMPALA LS, Blue, 65k, V-6, Auto, Full Power. Sale: \$9,250. John C. Miller Inc. 518-762-7124. www.johncmiller.com

ALPACA SWEATERS in stock. Hundreds to choose from. NEW luxurious styles. Warmer than wool, softer than cashmere, smoother than silk and hypo-allergenic. Paca Gardens, 27 West Main St, Little Falls, NY 315-823-1100 M-F 10-5, Sat 10-4. Layaways available.

PACA GARDENS has many styles of alpaca sweaters. Starting at just \$74.95. Alpaca is warmer than wool, softer than cashmere and hypo-allergenic. Alpaca products make great gifts. Layaways available. 27 West Main St, Little Falls. 315-823-1100 M-F 10-5, Sat 10-4.

FOR SALE: 1998 Dodge Neon \$500 315-956-2494

KING'S NEW & USED FURNITURE. Store hours 9-5 pm, Mon.*Wed.*Thurs.*Fri. & Sat. 689 Burrows Rd., West Winfield, NY. (315)822-5221.

FEATURE OF THE MONTH! 6lb. Pet Expert Dog Biscuits \$5.99 Fort Plain True Value and Just Ask Rental 12 Willett St Fort Plain 993-3834

WANTED - old water colors, oils, vintage clothing, bottles, traps, Adirondack furniture and frames. Contact Showcase Antiques at (315)823-1177

24/7/365 Shults Insurance Agency Is here for you! For all of your Insurance needs! 800-836-2885

2014 FORD FOCUS SE, Red, 24K, 4Cyl, Auto, AC, CD. Sale \$13,695. John C. Miller Inc. 518-762-7124. www.johncmiller.com

20x30 TENT with four sides for rent. Canajoharie Volunteer Fire Department 518-673-3812

WE HAVE! Timberwolf log splitters. Call for pricing + models available. North Creek Auto 315-866-3698

HUGE SPRING Consignment Auction JR'S Auction 7403 St Hwy 5 St Johnsville NY 518-993-4668 We are accepting consignment for a huge variety of items including: Farm Machinery, Equipment, Antique Farm Equipment, New and Used Furniture, Woodworking Equipment, Construction Equipment, Tractors, Lawn and Garden Tractors and Mowers, Small Animals, Animal Related Items, Tack new and used, Hand Tools, Power Tools, also already consigned from Syracuse is a whole tractor trailer load of Furniture, Tools, Windows, Doors, Hand Tools and more from Estate Clean Outs, Don't Miss This Auction 518-993-4668

183 Main Street, Sharon Springs, NY 13459: Legal live-in storefront with 1 to 2 bedrooms in Sharon Springs, NY. Very sunny, 1,000 s/f storefront with large front porch. 2 entrance doors will allow you to have a separate shop or to sublet part of the space to an independent shop-keeper to help with the rent. New kitchen appliances and shower. Beautiful setting. \$775/month includes heat and hot water. Tenant pays electric. Available June 1st or sooner. References and verifiable long-term employment a must. Best contact giacomo.dennis@gmail.com or call 518-312-3800 and leave a message.

WANTED - CASH PAID
For old jewelry, old buttons, books, dolls, toys, even if broken, 1970s older, 1960s & older: Clothing, Old frames, Christmas, Halloween items. Interested in almost anything old. Shirley 315-894-9032

APRIL SPECIAL- Char-Broil Vertical LP Smoker \$99.99 Behind every project is a True Value 12 Willett St Fort Plain 993-3834

BUYING GOLD AND SILVER. One piece or collections. Payment in CASH on the spot. THE GALLERY, 2 West Main Street, Saint Johnsville, NY 13452. Telephone 518-568-5121.

ANTIQUES WANTED! Tin signs, old iron toys, books, guns, advertising papers, WWII military items, crocks, lamps, furniture, pictures, pottery, postcards, jewelry. Anything old. Cash paid. 315-717-7295

NOW HIRING, FULL TIME POSITION AVAILABLE. Please stop in to get job application, no phone calls please. Fort Plain True Value 12 Willett St Fort Plain

4TH ANNUAL SPRING Consignment Auction- Saturday April 23rd 9:00am 7403 St Hwy 5 St Johnsville NY 518-993-4668. FARM MACHINERY, EQUIPMENT, TOOLS, BUGGIES, SLEIGHS, ANTIQUES, COLLECTIBLES, ANTIQUE, MACHINERY, FLOWERS, TREES, SHRUBS, NEW AND USED FURNITURE, NEW AND USED TOOLS, LAWN AND GARDEN TOOLS AND TRACTORS AND MOWERS. THE SELECTION WILL BE LARGE!! BRING YOUR ITEMS!!

LOOKING FOR RURAL HOME TO RENT in the Mohawk Valley area that allows pets and some livestock. 518-210-2066

2010 JEEP LIBERTY LMTD. 4x4, Brown, 67k, V-6, Auto, Leather, Alloys. \$16,495. John C. Miller Inc. 518-762-7124. www.johncmiller.com

WANTED: Someone to grind out 3 large maple stumps. Large equipment preferred. 518-673-5810. Insurance required.

WINTER WILL NOT BE THIS EASY ON US NEXT YEAR! Come in and see the great deals we have on Cub Cadet snowblowers and be ready when winter strikes! Behind every project is a True Value 12 Willett St Fort Plain 993-3834

RECORDS WANTED: We'll buy your old records from 1930- 1970. 45's, 78's, Albums, Rock-N-Roll, Blues, R&B, Country, etc. Call Pete 518-673-2384.

WILL BUY OR TRADE snowmobiles, ATV's and motorcycles. Call (518)568-8113

13 MONTH PHOTO CALENDAR only \$12.00. Call Beth at Lee Publications 518-673-0101 email bsnyder@leepub.com

PROVOST BROS. INC.
THE WATER PEOPLE
Since 1912

- Expert Well & Pump
- Sales & Service
- 4th Generation
- Gould & Sta-Rite Pump Dealer
- Year Round Service

Our 103rd Year

N.Y.S. DEC CERTIFIED VISA/MasterCard
518-868-2126 • SLOANSVILLE, NEW YORK

NOTICE TO PARENTS OF PRE-KINDERGARTEN REGISTRATION Pre-K ROCKS

Registration packets will be available May 23, 2016 – June 3, 2016. Parents interested in obtaining a packet should stop by the East Hill Office during the hours of 7:30 a.m. – 3:30 p.m.

For a child to enter Pre-Kindergarten in September of 2016, he or she must be a district resident, and at least four years of age on or before December 1, 2016. Parents must bring the child's birth certificate, an immunization record signed by a doctor, and proof of residency.

If you have any questions or concerns, please contact Mrs. Sherri Hodge at the East Hill Elementary School at 673-6310.

Mohawk Valley Ag LLC
Dutchman Stoves LLC
Mohawk Valley Fabrics
95 Willet Street, Fort Plain, NY 13339
518-993-2543

- IBA Dairy Supplies • Animal Health Specialties
- White Pine Shavings • Poulin Grains
- Hay & Grain Preservatives • Bird Seeds
- Muck Boots • Georgia and Rocky Shoes
- D-S Stoves • Blaschak Coal • Alaskan Stoves
- Chimneys & Firewood • Meadow Creek Grills & Seasonings • Fabrics • Socks • Coats
- Sewing Supplies • Novelty Items and More!

APRIL SPECIALS
10% OFF Barbecue Seasoning
\$10⁰⁰ OFF Per Ton Coal & Wood Pellets While Supplies Last
10% OFF All Quilting Material

2010 GMC Terrain AWD



Very nice inside and out. High miles, but excellent care. All service records available. Priced well below book at \$8,775. It is on the road and driven daily. Just passed NYS inspection. New tires and brakes. Call/Text Dale at 518 495-2384

WE NOW OFFER RENT-TO-OWN OPTIONS FOR AS LOW AS \$57.00 PER MONTH

Stop in and talk to us about financing your new custom built shed!

OUTDOOR FURNITURE **GIFT SHOP**
STORAGE SHEDS



COMPARE OUR QUALITY AND PRICING
We think you'll be glad you did.

Yoder's Quality Sheds LLC
Located at 278 Atswell Rd., Richfield Springs, NY
315-858-0841
Mon-Fri 8am-5pm • Sat 8am-3pm • CLOSED SUNDAY

Prepare Now for "Spring Showers"



Available in White & Brown

with **Plastmo** Vinyl Raingutters

Spring Showers can do more than bring beautiful flowers. They can permanently damage your home if your present rain-gutter system is defective. Plastmo is a long-lasting, maintenance free, leakproof rain-gutter system designed for fast waterflow and easy installation.

C.H. BURKDORF & SON
"Quality Building Materials" f
35 Hough St., St. Johnsville • 518-568-7016 • www.burkdorf.com

HERKIMER • FULTON HAMILTON • OTSEGO
BOCES
Learning for Life



Adult LPN Program

OFFERING HEALTH CARE TRAINING FOR OVER 50 YEARS

ACCEPTING APPLICATIONS FOR SEPTEMBER 2016 CLASSES PRACTICAL NURSING

- Full time 10 months
- Part time 20 months days
- Part-time 20 months evenings w/Saturday clinicals

Financial Aid is available to qualified applicants

At Herkimer BOCES we have a long tradition of training practical nurses. Our graduates come from diverse backgrounds and ages. Some come with no health care experience and are in need of training. Others are building upon existing nursing skills. One thing all our students hold in common, is a desire to continue their education and provide a brighter future for themselves and their families.

For complete LPN course description and application process visit on the web at: lpn.herkimerboces.schoolfusion.us or call 315-895-2210 Ext. 1 • 77 E. North St., Ilion, NY
New Location

PRESSURE TREATED LUMBER AND PLY-WOOD – fresh supply has arrived just in time for your spring outside projects! C. H. BURK-DORF & SON, 35 Hough St., St. Johnsville 518-568-7016

NEED A NEW CAR? Get 0% financing at Sampson Motor Car where everyone is approved! 261 East Main Street Amsterdam. 518-848-7359

NEW: Unusual Fenton art glass collection. Some pieces double signed by the Fenton family. Must see. THE GALLERY, 2 West Main Street, Saint Johnsville, NY 13452. Telephone 518-568-5121.

2001 DODGE DIESEL 4x4, extended cab, Laramie SLT, original owner, \$4700. 518-424-8455

INSULATION: All Types. New/ Existing Buildings. Free Estimates. Fully Insured. Call Upstate Spray Foam Insulation www.upstate-sprayfoam.com 315-822-5238

SHOWCASE ANTIQUES- taking Estate Consignments. We'll come to you! Antiques/vintage, nothing new. Call Showcase Antiques at (315) 823-1177

ST JOHNSTOWN house for rent, (5) bedroom, (2) full bath, (3) fire places, circular driveway, large yard. Security and references required. \$875 a month. Please call 315-867-3931 or 518-568-2776.

DOES YOUR APPLIANCE NEED REPAIR? Need prompt service that's affordable? Call KOVAL's Major Appliance Repair. (315)867-9333

CHECK YOUR AD. ADVERTISERS should check their ads on the first week of insertion. Lee Publications, Inc. shall not be liable for typographical, or errors in publication except to the extent of the cost of the first weeks insertion of the ad, and shall also not be liable for damages due to failure to publish an ad. Adjustment for errors is limited to the cost of that portion of the ad where in the error occurred. Report any errors to 518-673-0111

2012 HYUNDAI SONATA, Silver, 33K, 4cyl, Auto, CD, Alloys, Great on gas. Sale: \$14,495. John C. Miller Inc. 518-762-7124. www.johncmiller.com

ADVERTISERS: Get the best responses from your advertisements by including the age, condition, price and best calling hours. Also, we always recommend insertion for at least 2 issues for maximum benefits. DEADLINE for placing ads is THURSDAY 5pm prior to edition date. Call Peg 518-673-0111

WANTED - signs, old hunting, fishing items, furniture, porch chairs, barrels and 19th century stuff. Call Showcase Antiques at (315) 823-1177

REPAIRS AND ACCESSORIES for ATV's, Motorcycles and snow machines. Full Throttle LLC, 6 South Division, St. Johnsville, NY (518)568-8113

LOOKING for it? Selling it? Looking for work? Looking to hire... give us a call at 518-673-3237 to place your reader ad today.

SHEETROCK - 1/2" x 4'x8', 10', 12' and 14'. Also 1/2 x 4' x 8' moisture resistant and 5/8" x 4"x8', 10', & 12' fire code. Joint compound, tape, drywall screws and primer available to complete the job. C.H. Burkdorf & Son, 35 Hough St., St. Johnsville 518-568-7016

NEW FURNITURE - 5 deliveries just arrived, recliners, living room sets, coffee & end tables, kitchen & dining room tables and mattresses. Store hours 9-5 pm, Mon.*Wed.*Thurs.*Fri. & Sat. King's, 689 Burrows Rd., West Winfield, NY. (315)822-5221

RENTALS: Mini Excavators, Track Loaders, Compact TLB & more. Call Randall Implements, Rt. 5S, Fultonville 518-853-4500

FOR SALE: 1948 Ford 8N tractor with plow and attachments, \$3,000/OBO. Call 607-264-3680

CONSIGNMENT AUCTION every Saturday at 6:33 pm. Kings Auctions, 689 Burrows Rd., West Winfield (315)822-5221.

DO YOU NEED SOMEONE to do your Spring yard clean up? Little Falls, St. Johnsville, Fort Plain area. 518-844-7162

North Creek Auto Is a Dealer for Blizzard All Aluminum Trailers! Enclosed, Snowmobile, Car Haulers, Utility & Dump Trailers. 315-866-3698

THE PRODUCE BENEFIT AUCTION THIS YEAR WILL BE SELLING UP TO 100 HEAD OF HEIFERS, ANY AGE, CONTACT ALVIN STOLTZFUS 518-993-9926 IF YOU HAVE HEIFERS YOU WANT TO CONSIGN!! 840 FORDSBUSH RD FORT PLAIN NY, THIS IS CONJUNCTION WITH THE HUGE MOTHERS DAY AUCTION!! HUGE 2 DAY EVENT FRIDAY MAY 6TH AND SATURDAY MAY 7TH WATCH FOR OUR ADS!!

CENTRAL BOILER EClassic OUTDOOR FURNACES. Cleaner and Greener. 97% Efficient. EPA Qualified. Call North Creek Heat 315-866-3698



Call in your Reader Ad TODAY... 518-673-0111

Pick it up... Give us a call... For as little as \$4.00 per week!!!

**Looking for it?
Selling it?
Looking for work?
Looking to hire?
WE CAN GET IT DONE!**

MAKE OUR PHONE RING So WE CAN RETURN THE FAVOR!!!



Call the Original Valley Pennysaver to place your Reader Ad 518-673-0111



CANCER BENEFIT

for **ELMER
HORNING**

Sunday, April 17th • 1-5 pm
at the Elks Lodge in Nelliston

Live Music • Great Food • 50/50
Chinese Auction • Fundraiser Raffle



Adults \$10 - Children - Free



For tickets or questions contact Becky Skinner at 518-673-6181 or 518-231-9796

Roofing & Masonry Pressure Washing:
 Roof Replacements, Tear-off's, Shingle Over, Flat Roofs, Roof Cleaning. Brick & Stone Work: Masonry Repair, Repointing & Rebuilding. Chimney's, Fireplaces/Woodstoves. Free Estimates. WJC General Contracting 315-542-5509

2010 MERCURY MOUNTAINEER AWD, black, 57K, V-6, Auto, Heated Leather, Moon-roof. Sale: \$17,995. John C. Miller Inc. 518-762-7124 . www.johncmiller.com

CONSIGNMENT AUCTION every Saturday at 6:33 pm. Kings Auctions, 689 Burrows Rd., West Winfield (315)822-5221

OFFICE CLEANING
 Part time evenings, in Canajoharie, 5:30pm to 9:30pm, Monday - Friday. Also, Fort Plain and St. Johnsville, Sunday, Tuesday, Thursday, 5:30pm to 8:00pm. Above average pay, experience a plus, will train, call to set up interview. 518-725-3748 leave message.

KOBALT TRUCK TOOLBOX for full-size truck, 69x19x18, aluminum diamond plate, like new, cost \$350+, selling for \$200 firm. 518-568-7797

WOOD PELLETS - SPRING SPECIAL on New England Premium Wood Pellets. Buy Now & Save - C.H. BURK-DORF & SON, 35 Hough St., St. Johnsville 518-568-7016

The first tiny chick

by **Katrina Weaver**

It wasn't too long after our family moved to the country, that we decided to get a flock of chickens. We drove to the local farm store, where the shipment of chicks had just arrived. My siblings and I went over to look at the boxes of chicks. There were several different kinds of chicks there, as well as mallard ducklings. Being of a more practical mind, my mother and father picked several chicks of good laying kinds. My sister managed to catch two mallard ducklings, and my brother selected a fluffy chick with black dots on its head. However, I was looking intently at some bantam chicks mixed in with the regular chicks.

"Daddy," I questioned. "Can I get a chick for my very own?"

"Of course!" replied my dad.

So I reached in slowly and scooped one up of the gray chicks. "Cheep! Cheep!" it shrilled loudly.

I cupped my hand over it gently, and tucked it carefully into the box with our other chicks. Soon thereafter, they were settled under a heat lamp and given chick food and water.

The chicks grew quickly and we soon moved them outside into a chicken tractor (a moveable chicken pen with no floor) where they enjoyed the luscious clover, fresh air, and space to run around. Soon the young chickens began to lay eggs, and my chick, whom I had named, Little Chick, began to make some rather unexpected noises. It sounded kind of like a crowing cough — the sound that a young rooster makes before its voice is completely developed into a melodious crowing sound. What a surprise! Little Chick was a rooster! I was quite thrilled to have a bantam rooster for my pet.

Over the course of several years, various other chickens were added to our farm. A few died of natural causes; others became tasty dinners. But many of them became special pets, chief among these being my special never-to-be-sold-or-butchered rooster Little Chick. He was my beloved pet, and I am confident

that he loves me duly in return. But he was not so friendly to other members of the family. Sometimes he would fly at them in a flurry of feathers, his spurs out and beak ready. They soon learned to steer clear of him. My grandmother, while standing at a distance averred that he was "quite a character," chuckling good-naturedly.

Even though Little Chick was small, he was a natural protector of his hens. Once, our little black kitten tried to pounce on one of Little Chick's hens, but to Kitty's surprise, a furious little rooster descended upon her, spurs and beak flying. You can be sure she got out of there as fast as her shocked paws would carry her, ready to return to a cat's proper job of stalking mice.

Little Chick also shared delicious bits of food with his hens that he found while grazing. A worm, or a stalk of wheat was a wonderful treat. He would give a high shrill noise, to which the hens would come running, and gobble up the food, which he patiently kept for them until they came.

My chicken flocks have increased. Now I have new favorites among them. But none will ever take the place of Little Chick. For me, it all started with that one, tiny, cheeping ball of fluff, and then grew into more chickens, more eggs and more pets to love and take care of. Chickens make wonderful pets as well as laying fresh, healthy eggs. I would highly encourage you to get some for your own backyard. They are something that is very rewarding to raise.

Who knows? If you give chicken raising a chance, your heart may be unexpectedly stolen away by some "Little Chick."



The author with her bantam rooster, Little Chick.

Photo by Rose Weaver

✂ **CLIP & SEND**

Original Valley Pennysaver
 The Little Paper with **BIG** Results

Serving the Homes of the Mohawk Valley

PO Box 121, Palatine Bridge, NY 13428 • Ph: 518-673-0111 OR 800-218-5586

\$4.00/14 words \$1.10 each additional / Week

**Deadline Thursday Noon - Fill Out This Form
OR Call Us To Place Your Reader Ad**

• **READER AD FORM** •

Today's Date _____ # of Weeks to Run _____ Starting Issue Date (Saturday Date) _____

COPY: (First 14 words \$4.00, each additional word add 10¢ each)

14 words - \$4.00

24 words - \$5.00

34 words - \$6.00

(TELEPHONE NUMBERS = ONE WORD)

Name (Print): _____

Farm/Company Name: _____

Street: _____ County: _____

City: _____ State: _____ Zip: _____

Phone #: _____ Fax #: _____ Cell #: _____

Email Address: _____

Payment Method: Check/Money Order American Express Discover Visa MC

Card #: _____ Exp. Date: _____ MM/YY

Name on Credit Card (print): _____

Signature: _____ Today's Date: _____

Amount Paid: _____

**Ph: 518-673-0111 or 800-218-5586 • Fax: 518-673-2381 • Email: classified@leepub.com
 Mail: The Original Valley Pennysaver, PO Box 121, Palatine Bridge, NY 13428**

Longing for dandelions and daffodils

by Melissa Piper Nelson

Yellow is a cheerful spring color and it signals two precursors of the season, dandelions and daffodils.

Dandelions (taraxacum) are either gleefully greeted by those persons who see (and eat) them as a healthful spring tonic, or curse the yellow, top-tufted flowers and spear-like green leaves, as nature's enemies to a perfect lawn.

Growing up in the country, we didn't so much covet lush green lawns, and welcomed the little yellow flowers dotting our front yard as messengers: The long winter is finally over and spring has sprung! We picked hundreds of small bouquets to set in glasses

on the front porch or the dinner table just to remind everyone that we could actually see the front yard now that the piles of snow were gone.

To those not as fond of dandelions, the little yellow flowers represent a war of sorts. Find the enemy that dots a verdant field and destroy: flowers, leaves, roots and all! In fact, moving to a village, spring now seems to come when neighbors burst forth from their garages with pump sprayers in hand to rid everything evil, including dandelions, from their lawns.

But who among us does not remember picking up a dandelion flower turned white and spiky, blowing on the wisps and

sending the seeds out into the spring air? That in itself seems like a spring ritual each generation enjoys discovering.

Daffodils, (narcissus) on the other hand, enjoy a more universal appeal. Delicate and fluted, they lift their flowers out of the late winter snow to announce a new season appearing. Daffodils are

Longing 15



GET SET TO SAVE

SALES EVENT

Ready. Set. Save on Kubota's Z700 Series Zero-Turn Mowers.

\$0 Down, 0% A.P.R. Financing for 48 Months*

Offer ends 6/30/16.

RANDALL

IMPLEMENTS CO., INC.

2991 State Highway 5S • Fultonville, NY

518-853-4500

www.randallimpls.com

*\$0 down, 0% A.P.R. financing for up to 48 months on purchases of new Kubota Z700 Series equipment is available to qualified purchasers from participating dealers' in-stock inventory through 6/30/2016. Example: A 48-month monthly installment repayment term at 0% A.P.R. requires 48 payments of \$20.83 per \$1,000 financed. 0% A.P.R. interest is available to customers if no dealer documentation preparation fee is charged. Dealer charge for document preparation fee shall be in accordance with state laws. Inclusion of ineligible equipment may result in a higher blended A.P.R. 0% A.P.R. and low-rate financing may not be available with customer instant rebate offers. Financing is available through Kubota Credit Corporation, U.S.A., 3401 Del Amo Blvd., Torrance, CA 90503; subject to credit approval. Some exceptions apply. Offer expires 6/30/2016. See us for details on these and other low-rate options or go to www.kubota.com for more information. Optional equipment may be shown.

kubota.com

© Kubota Tractor Corporation, 2016

Hosted By Shu-Maker Mountain Climbers

★ New ★ Used ★ Vintage

SWAP MEET

Snowmobile, ATV, Motorcycle, Trailer, Parts, Etc.

Free Vending... Free Entry

Show Sleds Welcome... No Judging

FREE AUCTION AT THE END OF THE DAY

Food Provided by Shu-Maker Mountain Climbers

BRING WHAT YOU HAVE... FIND WHAT YOU NEED

Saturday, April 23, 2016

8:00am - 3:00pm

NEW LOCATION:

State Rt 5S, Little Falls, NY

Just off NY State Thruway Exit 29A - Little Falls

GPS Address: 130 Old Herkimer Road, Little Falls, NY 13365

Superior Plus

Energy Services

- Propane
- Heating Oil
- Gasoline
- Diesel Fuel
- Kerosene

- Dependable Fuel Delivery for Home or Business
- Easy Pay Budget, Fixed, Capped and Variable Plans
- Heating, Cooling and Hot Water Systems
- 24/7 Expert Service

Ryan Rockwell

Energy Solutions Representative

315-415-3260

Ed Johnson

Commercial Energy Solutions Representative

315-796-1603

118 State Highway 67

St. Johnsville, NY 13452

518-673-2681 • Fax 518-568-5056

www.superiorplusenergy.com

Available in most service areas

Ziebart
 Of Utica 912 SOUTH ST. 315-732-8185
\$50 off Full Detail Pkg. Reg. \$149.99
Rhino Linings
 Sprayed on truck bedliner
 Rust Proofing
 Undercoating • Detailing
 Wash, wax, windows, tires, rims, vacuum, shampoo, motor, complete interior etc.
315-732-8185

Ladies Golf Clinic
 6 Sessions Only \$99
 Begins April 27th
GOLF LESSONS
 By Mark Lane
 Head PGA Professional
 at Mohawk Valley Country Club
518-844-4558
 "I keep the rust off your swing"

DO YOU NEED TO SELL ITEMS IN YOUR HOME OR ESTATE?
 • Estate Liquidations • Downsizing Home
 • Relocating Selling Items • Moving Sale
 We handle the complete estate and moving sale of all home contents, item appraisal and price tags.
 Jeff Jones - Appraiser/Owner
 mvescny@gmail.com
 Cell 518-921-2992 Home 518-993-5333
 Mohawk Valley Estate Sales
 Jeffery Jones Sr. Veteran Owned
 81 Garfield St. Fort Plain NY, 13339
 C-518 921-2992 H-518 993-5333

Full Throttle LLC
 6 South Division Street, Saint Johnsville, NY 13452
518-568-8113
****Want to sell your machine? Call us first!!! Cash on the spot!!!****
 We buy, sell and trade ATV's, snowmobiles, and motorcycles
 • Many used snowmobiles and ATV's for sale meeting all price ranges!!!!
 • Refurbish four wheeler and snowmobile seats
 • Moose Plows sales and installation
 • All oils and snowmobile accessories
 • ATV tire sales and installation
 • Snowmobile tracks and installation
 • Helmets and Goggles
 • We fix Snow blowers, weed eaters, lawn mowers, ALL SMALL ENGINES
 • Most parts and accessories come next day
****WE WILL PICK UP AND DELIVER ALL MACHINES!!!!****

CNY Seamless Gutters
727-247-3290
 Facebook.com/CNYseamlessGutters
 • Gutter Installation • Gutter Repair, Resealing
 • Power Washing • Plumbing & Electrical Repair
\$75 off Any Whole Home Installation (gutters only)
\$25 off Any Partial Installation (gutters only)
Free At-Home Estimates

MEYERS LANDSCAPING & CONTRACTING INC.
 FULLY INSURED 518-673-2034 24 HOUR SERVICE

Contracting:
 • CONCRETE
 • SLABS
 • PATIOS
 • STAMPED CONCRETE
 • COLORED CONCRETE
 • FOUNDATIONS
 • SIDEWALKS
 • REPAIRS
 • PAVER BRICKS

Wood:
 • ADDITIONS
 • DECKS
 • SHEDS
 • RENOVATIONS
 • GARAGES
 • STEPS
Blacktop:
 NEW or REPAIRS
 • DRIVEWAYS
 • PARKING LOTS
 • SEAL COAT
 • LINE STRIPING

Roofs:
 NEW or REPAIR
 • SHINGLE
 • RUBBER
 • TIN

Retaining Walls:
 • CONCRETE
 • BLOCKS
 • WALL STONE
 • FIELD STONE
 • RAILROAD TIES

Landscaping:
 • SCREENED TOP SOIL
 • STONE
 • CRUSHER RUN
 • SEEDING
 • FERTILIZATION
 • BRUSH HOGGING
 • COLORED MULCH
 • NEW LAWNS & REPAIRS
 • TREE & STUMP REMOVAL (55' bucket truck)
 • FENCING (wood, metal, vinyl)

ROUGH WINTER DRIVEWAY REPAIRS

SPECIAL SENIOR CITIZEN DISCOUNT

Schedule NOW for Lawnmowing & Spring Clean-Up
Call Today For An Estimate

Running to make a difference
 by Elizabeth A. Tomlin
 While other 10-year-olds were busy playing games during the month of February, the Murphy twins, 10-year-old Christopher and Giana Marie, were busy running to make a difference in the life of someone they had never met.
 "They were wanting to make a difference when they heard that their friend, Trevor Ackert's, grandmother had cancer," remarked Ann Marie Murphy, mom of the twins and elementary teacher at Canajoharie's East Hill School. "They set their goals, got sponsors, kept a log of miles, and then collected their money when they were finished."
 The goal was to run 100 miles each. Taking pledges from family and staff at school, the 5th-graders set off to achieve their goal.
 Christopher enjoyed running the path at Knox Middle School, while practicing his soccer control skills. But, it wasn't an easy feat to run the miles in February, with many school activities and some days of inclement weather. "Giana fell behind one week and had to run 12 miles one Sunday," Murphy said.
 When they couldn't run outside, they ran on a treadmill. But on several nice days the family ran together, which Ann Marie says was, "the best part."
 The twins are not strangers to running to raise funds for a good cause, as two years ago, at only 8-years-old, they ran 100 miles to benefit the late Fulton County Sheriff Garth Hillier.
 "For the Murphy kids to commit to running 100 miles and to collect donations in such a short time is amazing," said Susan Stock, recipient of the donation. "Christopher and Giana are amazing, generous, caring kids. Their parents should be proud -and I know that they are."
 The Murphy twins raised \$1,200, with many pledges coming from the school staff.
 "The Canajoharie Central School faculty and staff were very generous



Susan Stock, center, is surrounded by her family at a benefit fund raiser on April 2. Seen here from the left, are daughter & son-in-law, Ashley and Matt Ackert, with their children Cameron and Trevor, Susan Stock, son Justin Stock and daughter Mackenzie Stock.



Murphy twins, 10-year-olds Christopher and Giana Marie, present recipient Susan Stock a check for \$1,200; money they raised by running 100 miles in one month.

Photos by Elizabeth A. Tomlin

Coop D'etat results in deportation of rebel

by Terry Berkson

Early this spring, my reigning rooster, Geezbrook, who fathered almost all of this year's egg-laying rookies, was challenged and defeated by one of his sons. When I arrived on the scene the old man was cowering in a corner with his back facing his attacker. I scooted them out into the yard and they went at it again, Geezbrook seeming to have new heart against his son who got down like an alligator coming through a fan of feathers. They both drew blood with the old man losing the fight until I slapped them both several times with my red plastic shovel. Distracted, they headed for cover in a hedgerow.

When I went back to the coop to gather eggs I noticed that several of the hens had bald spots on their backs, caused, no doubt, by the roosters practicing their dominance. Luckily Pee Wee, my favorite chicken, hadn't suffered any damage or I would have gone after the bullies with hatchet in hand. Instead, I tried to catch them which was no easy task after they had had a taste of the shovel. I needed to know which rooster was abusing my hens so that I could pack him up and ship him off to King's every-second-Sunday auction in West Winfield. Actually, you don't need any roosters to keep the hens laying eggs. You

Rebel 14



Rhino Linings
THE SPRAYED-ON LINER™

\$50 OFF
Rhino Lining



Rhino Linings of Utica
912 South St.
315-732-8185

Customer SAVINGS!

With Coupon - Expires 4/30/2016

Dutch Country Market

"Where price and quality meet"
Formerly "Country View Discount Groceries"

Prices Effective 4/14 to 4/21



JOHN F. MARTIN & SONS
Celebrating 55 Years 1961-2016

PREMIUM DELI MEATS AND CHEESES SINCE 1961



Sweet Lebanon Bologna
\$3.99 Lb.



Black Forest Honey Ham
\$2.99 Lb.



Meunster Cheese
\$2.30 Lb.



5 Lb. Golden Delicious Apples
\$4.99



Cream Cheese
.99¢

56 Willett Street Fort Plain, NY
Mon Thru Fri 8:00 am to 5:00 PM,
Sat 8:00 AM to 2:00 PM, Sun closed

The Ultimate Golf Gift

GOLF LESSONS
from Mark Lane
Head PGA Professional
at Mohawk Valley Country Club
518-844-4558
"I keep the rust off your swing"





Clarity
HEARING SERVICE

FREE HEARING SYSTEM
Buy One Open-Fit Hearing System & Receive Second System **FREE**

You Should Hear What You've Been Missing!
315-796-7491



Got PROPANE?

Free Hook-up • NO Hidden Fees
Lock-In Pricing

- Senior Discount • Cash Discount •
- Budget & Prepay Plans • HEAP •
- Multiple Product Discount •
- Service Contracts • 24 Hour Sales & Service •

Locally Owned Company Delivering...



?

- PROPANE
- HEATING OIL
- DIESEL
- KEROSENE
- GASOLINE

Harbor Point

ENERGY PRODUCTS

132 East Main St., Frankfort, NY
315-894-4328 (HEAT) • 315-732-4328 (HEAT)
53 West Main St., St. Johnsville, NY
518-568-5228
HarborpointEnergyProducts.com

MAPLE RIDGE BULK FOODS

~ Deli Specials ~

Eggs - \$1.50 Doz.			
Turkey Ham	\$3.87 lb.	Meunster Cheese	\$3.95 lb.
Honey Turkey Breast	\$5.50 lb.	Mozzarella Cheese	\$3.95 lb.
Roast Beef	\$5.99 lb.	Provolone Cheese	\$3.84 lb.
Sandwich Pepperoni	\$5.19 lb.	American Cheese	\$4.99 lb.
Buffalo Chicken	\$4.95 lb.	Pepperjack Cheese	\$3.99 lb.

Potatoes - \$14.50/bag, 10lb. Potatoes \$4.00

Mon-Sat 8am-5pm • Closed Sun • **315-219-1238**
 629 Mang Rd, Little Falls, NY 13365
 Located off Rt. 29 in Salisbury Center. Take North Rd. to Mang Rd.

315-868-8207

Swarey Bros. Roofing

12 Years Experience!

Aaron Swarey
Canajoharie, NY

Shingle • Metal • Rubber

WE'VE GOT YOU COVERED!
Free Estimates - Family Owned

No Games! No Gimmicks!
No Monkey Business!
JUST ONE LOW PRICE!!
Beat The Spring Rush Call Today

OPEN SUNDAYS

T&J

FRUITS / VEGETABLES & GREENHOUSES
CELEBRATING 43 YEARS

We carry McCadam Cheese, Hapanowicz Meats, Queensboro tub butter and Farm Fresh Milk!
WE ACCEPT ALL MAJOR CREDIT CARDS & EBT CARDS

COMING NEXT WEEK
SEED POTATOES

NOW IN - STUTTGARTER & RED ONION SETS

THIS WEEK'S SPECIALS

CALIFORNIA LETTUCE OR ROMAINE ~ 99¢/EA.
 Red Seedless Grapes ~ \$1.99/LB.
 RED OR SUNTAN PEPPERS ~ \$1.99/LB.
 10LB BAG OF POTATOES ~ \$2.99

LOCAL MAPLE SYRUP, HONEY & SHARP CHEESE

~ **Hapanowicz** ~

- Kielbasa • Mushroom Stew • Chili
- Chicken Cacciatore • Chicken Soup
- Greens & Beans • Potato & Cheese Pierogies

221 S. Caroline St., Herkimer • (315) 866-7272
 Serving You 7 Days A Week All Year Round
 Open: 8am-6pm



Farm & Tool Line

682 Fordsbush Road
Fort Plain, NY 13339
518-527-6838



NOT JUST YOUR AVERAGE FARM STORE!

- Redmond Products
- Keystone Mills Products
- Animal Feed: Small to Large
- Animals - Bird Seed Available
- Organic & Non-organic
- Animal Health Speciality Products
- Molasses
- Salt Blocks
- Udder Comfort
- Dog Food
- Barn Dri
- Gypsum Products
- Shavings

KEYSTONE MILLS
Serving Agriculture Since 1894

Our goal is to offer quality products at a fair price.



PATRIOT FEDERAL BANK

Local Banking.... Local Decisions

Banking The Way You Remember It!

Open Saturday:
Lobby & Drive Thru 9am-12pm

Yesterday's Values, Today's Technology • PatriotFederalBank.com

211 Erie Blvd., Canajoharie
(518) 673-4400



The Perfect Gift



vs.



New York Yankees Boston Red Sox

Saturday, July 16
at Yankee Stadium

A \$25.00 deposit (total price \$129) will reserve a place on the bus to NYC and stadium seat.

Bus leaves 9:00am from Dolgeville High School with additional pickups at Little Falls and Canajoharie Thruway exits. Game starts @ 4:05 pm

For reservations or more information please call:

(315) 867-3931
 (315) 429-9884
 (315) 429-8409
 (518) 568-2776

Sponsored by The Dolgeville Rotary Club and Violet Festival Committee

Rebel from 13

only need them if you want to hatch the eggs. It is nice, though, to hear a rooster crow in the morning.

Geezbrook hadn't given me any trouble up until now, so I figured it was one of his coercive sons that was abusing the girls. There was no running these rebellious youngsters down, so I had to set a trap and bait it with cracked corn. The door was held open by a stick on a long string with me at the far end hiding behind a low cedar. Several times I looked over my shoulder to see my wife, Alice, at the window shaking her head in disapproval. Undaunted, I held my ground for most of the day because I knew at least one of these roosters had to go. I eventually caught the culprit that was fighting with Geezbrook and boxed him up for shipment to the block.

When Sunday came around, my wife turned down a "cheap" date to the auction, so, alone, I drove to Winfield and pushed the rebel's box across King's counter. They gave me a number, which I sat on in the bleachers. I could hear my rooster crowing, "Why me, why me?" above all the other birds in the building. Serves him right, I thought, for picking on his father. I didn't let myself get sentimental and just sat there wondering what the troublemaker would go for. The five bucks was still warm in my pocket as I headed for home. That was easy I thought. One rebel down and maybe one more to go. For a while the regime seemed secure.

A few days later I received a postcard marked from Albany. The handwriting was so scratchy I could barely make it out. It was signed by the rebel telling me that the slaughterhouse truck he had been riding on didn't make it under a low underpass and that his crate was swept onto the road where it broke into a hundred pieces. Unscathed, this bird was telling me that he was on his way back with spurs intact and a beak ready for battle. I pictured myself waiting by the coop with the red shovel in hand. At all costs, Geezbrook would still rule the roost.

Then Alice slyly looked me in the eye and handed over the rest of the mail.

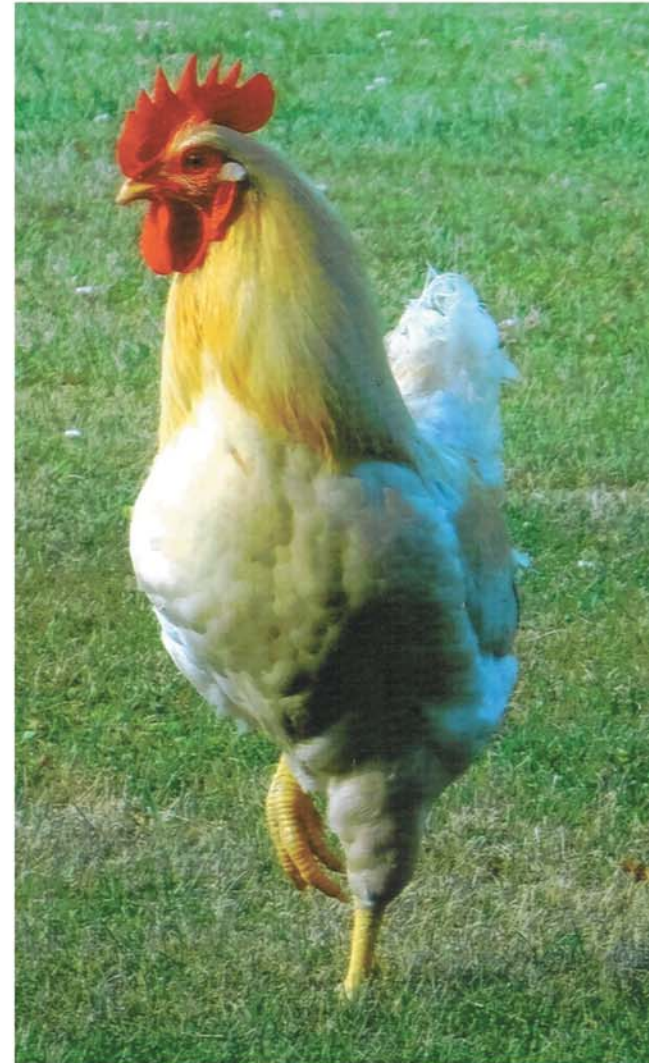

The author's rooster Geezbrook ruling the roost. Photo courtesy of Terry Berkson

Comfort Foods Made Fast And Healthy

by Healthy Exchanges Pineapple Green Beans

A taste of Hawaii!
1/2 cup chopped onion
1 (8-ounce) can pineapple tidbits, packed in fruit juice, drained and 1/4 cup liquid reserved

1/4 cup water
1 tablespoon cornstarch
1 1/2 teaspoons reduced-sodium soy sauce
2 cups frozen cut green beans, cooked, rinsed and drained

1. In a large skillet sprayed with butter-flavored cooking spray,

saute onion for 5 minutes.

2. In a covered jar, combine reserved pineap-

Running from 12

and supportive of these two students and I am very thankful for everyone involved," remarked Stock.

Susan is battling cancer and her friends and family recently put on a benefit at the South Minden Fire House to assist her with medical bills. "I feel extremely blessed to

ple liquid, water and cornstarch. Shake well to blend. Pour mixture into skillet with onion. Stir in

have family and friends that put so much of their time and effort getting donations, making food and asking volunteers to help."

Stock said it took at least two to three months for her friends and family, including Deb Darrow, Flora Stock, Ashley Ackert, Cindy Warn,

soy sauce. Add green beans and pineapple tidbits. Mix gently to combine.

Stephanie Snyder, "and many, many other people too many to name and I probably would forget someone - a lot of hard work - and they did it because they are good people and have lots of love in their hearts. This time the love was for me and I truly appreciate everything and every single person that was involved."

What do the twins say about their good deed?

"It feels good to help others!" they agree.

3. Continue to cook over medium heat for 6-8 minutes or until mixture thickens and is heated through, stirring constantly. Divide into 4 servings.

Tip: If you can't find tidbits, purchase pineapple chunks and coarsely-

chop.
* Each serving equals: 76 calories, 0g fat, 1g protein, 18g carb., 68mg sodium, 37mg calcium, 2g fiber; Diabetic Exchanges: 1 Vegetable, 1/2 Fruit; Carb Choices: 1.

(c) 2016 King Features Synd., Inc.

Longing from 11

popular enough to be chosen as positive symbols for charities, represent new hope and awakening and be immortalized in poetry. William Wordsworth wrote of them, "fluttering and dancing" in the breeze much to his delight. And, one doesn't usually pick or purchase a single daffodil, but bunches of them. The more in a bunch, the more intensely beautiful the picture.

Homeowners don't seem as adverse to

the delicate yellow daffodils fluttering about their landscaping either. Instead, bragging rights are unleashed when the first patches of the flowers peek out of the snow and decorate barren flowerbeds.

Little yellow flowers are harbingers of spring. We either love or hate them, depending on the variety, but we cannot deny their presence, or their message. Spring is on the way!

**A Great Business Opportunity
in Canajoharie**

2 Booth Salon For Rent
Heat, Water, Washer & Dryer Included

518-853-4399

OESJ Central School District

SCHOOL BOARD

Dun-Dun-Dun-Dun
(Theme Song from Jaws)

Coming To A
Voting Machine Near You!

CANAJOHARIE YOUTH CENTER

Basket Raffle

OVER 40 BASKETS & GIFT CERTIFICATES
TO LOCAL RESTAURANTS & BUSINESSES

FRIDAY, APRIL 15TH

**You Do Not Need To Be
Present To Win!**

NAMES FOR BASKETS
DRAWN RANDOMLY!

Tickets Are Only \$2.00 Each

Available at
Youth Center, Erie Blvd., Canajoharie
Lee Publications, Rt. 5, Palatine Bridge
Liberty, 7 Main St., Fort Plain

To Benefit CYC Summerfest Program





2 Big Weekends



Garage Sale

April 16th & 17th & April 22nd, 23rd & 24th

11 Ridge Terrace West, Canajoharie 9am-5pm

Tools - Tools - Tools

Too many to list!

Lawn and garden equipment including tillers, seeder, brushhog, John Deere sod plow, John Deere x748 lawn tractor with mower deck, John Deere 2210 lawn tractor with front loader, backhoe, mower and snow blower available!

Many Household items are also available!

Welders, Torches,
Raikes Bears, Christmans Tree & Decorations
Household Items & More



RADIO RODNEY WINS AGAIN! Can you guess which car belongs to Rodney?

Answer: Number 3.

Junior Whirl

by Charles Barry Townsend

CAST YOUR EYES ON THIS PUZZLE!

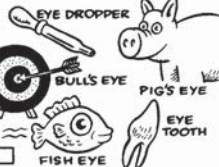
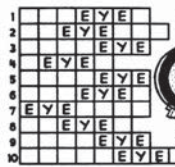

The "eyes" have it when it comes to interesting words. The grid to the left has room for 10 words, and they all contain an "eye." Hints are given below.

1. What the bad golfer did.
2. Native American buffalo hunters.
3. An expert marksman.
4. Ruined auto paint job.
5. What the weary cowboy needed.
6. How the weary cowboy came into town.
7. To look over.
8. What the predator did.
9. Ohio's nickname.
10. What they did before the king.

Answers: 1. Bogeys (State); 2. Cheyenne; 3. Deadeye; 4. Ripped; 5. Shrove; 6. Moseyed; 7. Eyeball; 8. Prayed; 9. Buckeye (State); 10. Curses.

FREDDIE THE FEATHER FANCIER! The other day, Freddie bought 20 birds for \$20. Pigeon cost \$4 each, canaries 50 cents each, and budgies 25 cents each. Can you figure out how many of each he bought?



Answer: He bought 3 pigeons, 15 canaries and 2 budgies.

LINK-UPS! Here's a list of 12 short words, divided into two columns. Turn them into six longer words by linking them together. To do this, draw a line from one word in the left column to one word in the right.



Answers: Ripped, Overages, Capable, Busted, Wits, Parrot.



The trouble with practical jokes is that very often they get elected.

~Will Rogers



Answers
Solution time: 21 mins.
King Crossword

Stickers Answer
"Towards die many times before their deaths; the valiant never taste of death but once."

R.F.D.



STICKELERS by Terry Stickels

Below is a jumbled quote from Shakespeare ("Julius Caesar"). See if you can unscramble the words to come up with the correct quote.

"Death times many before; cowards but taste once never the die of their valiant deaths."

©2016 King Features Syndicate

King Crossword

ACROSS

- 1 Not as much
- 5 Ump
- 8 "The Da Vinci —"
- 12 Send forth
- 13 Hosp. section
- 14 From the start
- 15 Turkish city
- 17 Pleasant
- 18 Urban carrier
- 19 "Fear —"
- 21 Grown-up
- 24 Verdi opera
- 25 Zilch
- 26 Crusoe or Gilligan
- 30 Actor Danson
- 31 Suggest
- 32 First lady
- 33 U-235 and U-238
- 35 Actress Barbara
- 36 John Irving's "A Prayer for — Meany"
- 37 Part of WWW
- 38 Panhandler
- 41 London's — Gardens
- 42 Breather?
- 43 Columbus' benefactor
- 48 Exam type
- 49 Suitable

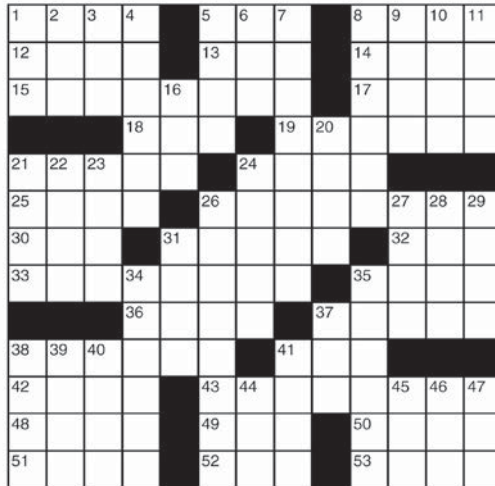

- 50 Rod partner
- 51 Carry
- 52 Deposit
- 53 Bigfoot's cousin
- DOWN**
- 1 Floral garland
- 2 Type squares
- 3 Perch
- 4 Not wobbly
- 5 Barbecue fare
- 6 Old French coin
- 7 Satisfies
- 8 Moulin Rouge dance
- 9 Taking care of business
- 10 Arp's art
- 11 Basin accessory
- 16 Wacko
- 20 "An apple — ..."
- 21 Opposed
- 22 Accomplishes
- 23 Loosen
- 24 Colorado ski mecca
- 26 Regal
- 27 Cherished
- 28 Satan's specialty
- 29 Tear
- 31 Midwestern
- 34 Two-position switch
- 35 NYC area, with "the"
- 37 Charlotte's creation
- 38 Rorschach picture
- 39 Modern-day coin
- 40 Summertime pest
- 41 Perry of pop
- 44 Hot tub
- 45 Director
- 46 Allow
- 47 — Baba

HOCUS-FOCUS

BY HENRY BOLTINOFF



Find at least six differences in details between panels.

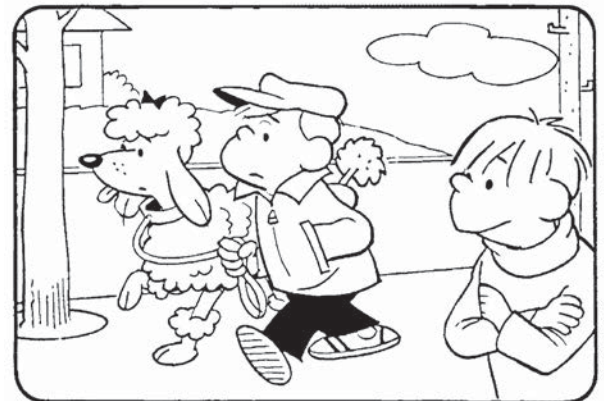

Differences: 1. Tree guard is missing. 2. Bow is smaller. 3. Tail is shorter. 4. Cloud is different. 5. Fireplug is missing. 6. Crossed arms are switched.

New! 24 HOCUS FOCUS puzzles \$3.50 • 24 Volumes • Order at: rbmall.com

Weekly SUDOKU

by Linda Thistle

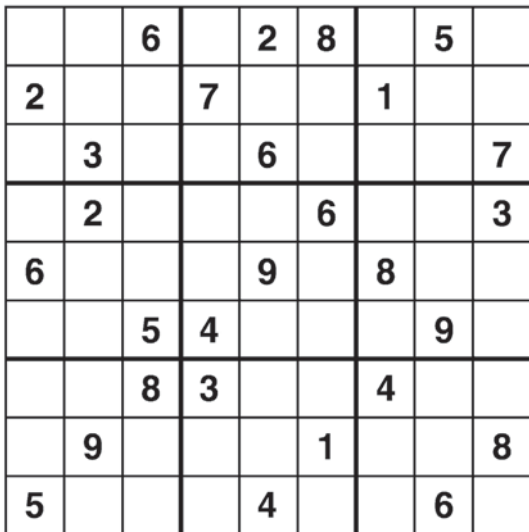

Place a number in the empty boxes in such a way that each row across, each column down and each small 9-box square contains all of the numbers from one to nine.

DIFFICULTY THIS WEEK: ★★

★ Moderate ★★ Challenging
★★★ HOO BOY!

© 2016 King Features Synd., Inc.

© 2016 King Features Synd., Inc.

©2016 King Features Synd., Inc.

Ayres Animal Shelter

133 Hilltop Rd., Sprakers • 518-673-5670

Hours: Tues-Sat 12-5 • Open Wed. Nites till 7PM • www.ayresanimalshelter.com



TYSON - 4 year old brown and white male Pit Bull, 81 lbs. Knows commands, loves car rides, swimming and treats. Good with some dogs and older kids, not good with cats.



DOOLEY - 2 - 3 year old black and white male Pit Bull. Found on Schultze St., Canajoharie on November 24, 2015. He's a love bug! Likes long walks, car rides and playing ball. Not good with kids.



SASHA - Beautiful female Husky/Chow mix. Came to the shelter because her owner could no longer care for her. She's fine with cats.



POPPI - 1 year old male Rottweiler. Nice and friendly. Came to the shelter February 28, 2016. Good with other dogs and with older kids.



JAX - 1 1/2 year old Yellow Lab/Boxer mix, 70 lbs. Knows "sit, lie down, shake". Crate trained. Loves to play fetch and go in the water. Good with some dogs, not good with cats or kids.



BERNIE - Adult male Bulldog. Found on Dygert Road, Town of Palatine on March 13, 2016. He's a sweetheart! Not good with dogs, cats or young kids. Housebroken.



RYLIE - 2 - 4 year old female Pit Bull mix. Came to the shelter in May 2015. Knows "sit" and "shake". Not good with other dogs or with cats. Fine with older kids.



APRIL - Beautiful 2 year old female Pit Bull mix, 57 lbs. Came to the shelter in August 2014. Low-key and very loving. Good with some dogs, not cats or kids.



FAY - 1 - 2 year old female Boxer mix. Found in Rockwood State Forest in August 2015. Good with some dogs but not cats. Older kids only.



BRANDI - 2 - 4 year old female Bulldog mix. Found at the Dunkin' Donuts in Fultonville on May 22nd. Good with some dogs, not cats. Fine with older kids.



SHELLI - 1 - 2 year old female Lab mix. Found on Flannigan Road, Canajoharie in October 2015. Good with some dogs and some cats. Fine with kids.

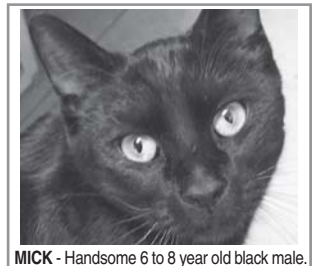

MICK - Handsome 6 to 8 year old black male. Found on Lynk St., Sprakers in January 2015. Great personality, very playful. Good with some cats, not dogs. Official "greeter" in cat room.



CLOVER - Beautiful 2 year old female Calico. Found under a dumpster in Fonda on December 6, 2015.



DONNY - Wonderful 7 - 8 year old large orange and white male. Found abandoned in a box in September 2011. Very playful. Fine with other cats and with dogs.



OLIVER - Large 2 year old black male with a wonderful round face. Came to the shelter in December 2015.



GYPSY - 2 year old gray and white female. Actually walked into the shelter on January 27, 2016! She's a charmer with a sweet face.



JENNY - Lovely 1year old female with classic tabby markings. Found on Mohawk St., Canajoharie on February 19, 2016. Fine with other cats.



HOOVER - Magnificent 3 to 4 year old male. Found on State Highway 80, Fort Plain on January 4, 2015. Very affectionate. Good with some dogs. Hoover has FELV.



ADOPT A NEW BEST FRIEND!

Thank you to the following merchants who sponsor this page every week.

<p><i>"The Place Where Good Friends Meet"</i></p> <p>55 Diner FORT PLAIN, NY</p> <p>TAKE OUTS AVAILABLE • 518-993-5306</p>	<p><i>Shear Delights</i></p> <p>Trisha Mattice</p> <p>Dutchtown Plaza Palatine Bridge, NY 13428 518-844-1173 shear_delights@yahoo.com</p> <p>Appointments appreciated/Walk-ins welcome</p>	<p>NEW YORK AUTOMOTIVE REPAIR St. Johnsville</p> <p>BRAKE SPECIALS EXHAUST SPECIALS • OIL CHANGES</p> <p>518.568.2277</p>	<p>RE Richard Euler Real Estate</p> <p>Licensed Real Estate Broker</p> <p>48 Church Street, Canajoharie, NY</p> <p>Office: 518-673-3677 Fax: 518-673-3477</p>	<p>BIG M The Licari Family</p> <p>St. Johnsville LITTLE m MARKET</p> <p>15 Lumberport Street, Delgetville, NY 315-429-8518</p> <p>25 West Main Street St. Johnsville, NY 518-568-5689</p>	<p>PATRIOT FEDERAL BANK</p> <p>211 Erie Blvd., Canajoharie • 518-673-4400</p>	<p>Husqvarna</p> <p>FOREST & GARDEN EQUIPMENT</p> <p>CHARLES D. STAHL SALES & SERVICE</p> <p>401 North Main Street • Canajoharie, NY 13428 315-823-1982</p>	<p>THE TIRE SHOP ON THE FARM SERVICE</p> <p>Multi-Line Dealer • New • Used Tires</p> <p>Tire Repair • Custom Wheels CAR & TRUCK ACCESSORIES</p> <p>155 Erie Blvd, Canajoharie, NY 518-673-5399 • Mon-Sat 8-6</p>
<p>McFee Memorials EST. 1963 OLD CRAFTSMANSHIP ENGLISH LETTERING</p> <p>MONUMENTS • MARKERS CEMETERY LETTERING STONE CLEANING</p> <p>48 Hancock Street Fort Plain, NY 13329 518-993-2239 Maez Carter/Henriksen</p>	<p>Frank's Welding & Fabrication Est. Since 1978</p> <p>339 East Main Street Canajoharie, NY 13317</p> <p>518-673-2797 Frank L. Snyder</p>	<p>BEHIND EVERY PROJECT IS A True Value.</p> <p>Just Ask RENTAL</p> <p>12 Willett Street, Fort Plain, NY 518-993-3834</p>	<p>of Palatine Bridge</p> <p>McDonald's</p>	<p>Barrett's Transmission GENERAL REPAIR</p> <p>Garry - Jason Barrett Owners</p> <p>148 Ripple Road Cherry Valley, NY 13320</p> <p>Phone & Fax 518-993-2002</p>	<p>Wrath of Grapes</p> <p>Over 12,000 Bottles of Wine to Choose From</p> <p>51 Hancock Street, Fort Plain, NY "Your Wine Superstore" 518-993-2624</p>	<p>The Shults Insurance Agency</p> <p>Call for insurance quote 800-836-2885</p> <p>Fort Plain ~ Johnstown</p>	<p>SIG AUTOBODY</p> <p>Specializing in Restorations Collisions to Full Paint Major to Minor Repairs</p> <p>4 South Division St. Johnsville, NY 13452 Scott Wolfkiel-Owner 518-568-8088</p>
<p>NAME TAGS • DESK PLATES • ENGRAVED SIGNS • PLAQUES & TROPHIES</p> <p><i>Say It With Signs</i></p> <p>Ronald J. Dygert 198 Dygert Road, Palatine • 993-4296 email: dygert@frontier.net</p>	<p>Valley View Apartments 62 Years or Older OR Disabled, regardless of age, please call for an application 518-673-8244</p> <p>Amenities include: carpeting, appliances, laundry facilities & parking</p>	<p>Saltzman's Hotel Since 1813 Junction of Rtes. 67 & 10 Ephratah, New York www.saltmans.com</p> <p>"A Unique Step Back In Time At Affordable Family Prices"</p> <p>For Reservations: 518-993-4412</p>	<p>In The Family 3 Generations</p> <p>MATTICE YOUR INDOOR COMFORT CONTROLLER</p> <p>HEATING - PLUMBING - COOLING</p> <p>Licensed Master Plumber Fully Insured - Free Estimates Residential & Commercial</p> <p>Justin Mattice 518-441-0142 Palatine Bridge, NY matticeandsons@yahoo.com</p>	<p>The Hearn Agency JACKSLAND ASSOCIATES INC.</p> <p>INSURANCE SERVICE</p> <p>Monday-Friday 8:30-4:30 209 Erie Blvd. PO Box 329, Canajoharie, NY 13317</p> <p>Phone: 518-673-3263</p>	<p>HILL TOP TIRE</p> <p>402 State Hwy. 163 Fort Plain, NY 13339 518-993-2235</p>	<p>Roosevelt's Est. 1936</p> <p>COMPLETE AUTOMOTIVE & COLLISION SERVICE CENTER</p> <p>210 Erie Blvd., Canajoharie 518-673-3214</p>	<p>Tim's GENERAL PHASES CONTRACTING</p> <p>Snowplowing, Plumbing, Electric, Kitchen & Bath, Remodeling, Masonry, Siding & Windows, Minor Landscaping & Small Backhoe Work, Additions, Furnace, Boiler & Wood Stove Installations, Etc.</p> <p>"100' Roofer" Professional Drain Cleaning 24 HOUR SERVICE</p> <p>Tim Lighthall 518-993-2504 • 518-265-5848</p>

FUCCILLO AUTOPLEX

Find Us On facebook



Over 400 Vehicles Available for Immediate Delivery
FINANCING AVAILABLE at www.gethugecredit.com
Rt. 5, Nelliston, NY • 518-993-5555

IT'S HUGE

EMPLOYMENT OUTLOOK

Wait Staff Bartenders & Cooks Wanted

Qualified Candidates Only
Please Call
518-222-9312
for appointment

Dining, entertainment & celebrations...

PANCAKE BREAKFAST
Rockwood - Garoga - Lassellville VFD
RGL Station 2, Lassellville, NY
Sunday, April 17, 2016 • 7am - 11am
Menu Includes: Pancakes, eggs, sausage, homefries, gravy, applesauce, coffee, juice, milk
Adults \$7 Children under 10 \$4.50 Under 5 free

**Dine In Or
Take Out**
993-5306

Thursday, April 14th

- ◆ Chicken-N-Biscuits w/Veg
- ◆ Sausage Patty w/Pepper & Onions Sandwich w/FF

Friday, April 15th

- ◆ Fresh Haddock Dinner - Baked or Fried w/Pot & Veg
- ◆ Mac & Cheese w/Veg
- ◆ Manhattan Clam Chowder

Saturday, April 16th

- ◆ Prime Rib w/Potato & Veg 3-7 PM
- ◆ Fried Shrimp w/Potato & Veg

Sunday, April 17th

- ◆ Stuffed French Toast
- Breakfast Only • Closed at 12:30 PM

Monday, April 18th

- ◆ ALL YOU CAN EAT PANCAKES 3-7 PM
- ◆ Tuna Noodle Casserole w/Veg
- ◆ Chicken Tender Cold Plate

Tuesday, April 19th

- ◆ BBQ Chicken w/Potato & Veg
- ◆ Mexican Club w/FF

Wednesday, April 20th

- ◆ ALL YOU CAN EAT SPAGHETTI 3-7 PM
- ◆ Giant Mushroom Burger w/FF
- ◆ Spaghetti w/Meatballs, Hot Sausage and/or Toss Salad

Thursday, April 21st

- ◆ Chicken-N-Biscuits w/Veg
- ◆ Cheeseburger Wrap w/FF

Homemade Soups & Desserts
Hours: Mon.-Sat. 7 AM-7 PM
Sun. 7 AM-12:30 PM
12 Hancock St.,
Fort Plain
FREE WI-FI

Rt. 80 Bowl
VanHornesville
Open 11am Mon-Sat
Noon on Sun

SMORGASBORD

Sat., April 16th
5-9 PM

**Roast Beef, Ham,
& Turkey**

Adult \$12.50 • 12 & Under \$6.25

315-858-2149

ALL YOU CAN EAT

PANCAKE BREAKFAST

at the Ephratah Rod & Gun Club
Route 67, Ephratah



Enjoy pancakes, sausage, eggs, home fries, pure maple syrup, chicken gravy, sausage gravy, applesauce, coffee, orange juice, milk

Cost: \$8.00 - ages 12 & up
\$3.50 - ages 6-11 • 5 & under - FREE

SUNDAY, April 17, 2016
7 am till 12:00 noon

TO BENEFIT THE ROYAL MOUNTAIN MOONLIGHTERS

Entertained Over 5,000 Events

"Entertaining Upstate New York For Over 30 Years"

CAPITALAND ENTERTAINMENT DJ Service



Wedding Packages starting at \$479

*Choice Dates Available
For This Holiday Season*

Sweet 16 Parties starting at \$295

- Wedding Receptions
- Graduation Parties
- Holiday Parties
- Birthday Parties
- Sweet 16 Parties

518-848-3880

518-775-3325



Keithshoemaker24@yahoo.com

www.capitalandentertainment.com

Thumbtack: Capitaland Entertainment

Facebook: Capitaland Entertainment

"Thumbtack Rated Us" The #1 DJ Service in the Mohawk Valley!

Whatchamacallits

Continuing with our cooperage theme, this week we have a grouping of three unusual tools created specifically for the barrel maker. This particular group was manufactured in the 19th century and are: a barrel croze plane (top); a leveler plane (left) and a howell plane(right).

The croze is the groove that runs around the inside of the top and bottom of the cask which held the head in place and is cut using the croze plane or cooper's router.

As you can imagine using this tool requires a lot of strength. The cooper has to cut the groove straight and at a uniform depth while working on a slope inside a circular container. The leveler plane was used for leveling the ends of the oak staves — the slats that make up the barrel sides — once they were held together with the hoop. Our last tool, the howell plane was actually used before the croze plane to make a howell (or lip, if you will) around the inside of the barrel. The croze is made afterward in order to hold the head (barrel end).

There is a fascinating video on YouTube called **Making barrels for Guinness in old times** that shows similar tools (and more) in actual service

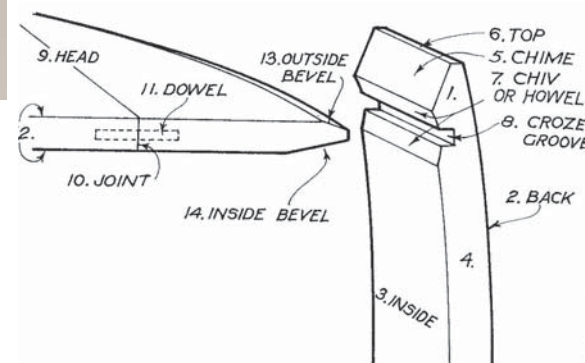

Do you have your own Whatchamacallit?

Send a photo and short description to csuo@leepub.com or call Colleen at 518-673-0145

Antiques & auctions... Going, going...yours!

Calendar of events

ORIGINAL VALLEY
PENNSAVER

NOTE: Calendar entries must arrive at the Original Valley Pennsaver office by Wednesday, April 13th for them to be included in the calendar of events for our Saturday, April 23rd issue. Send events to Lee Publications c/o The Original Valley Pennsaver, 6113 State Highway 5, P.O. Box 121, Palatine Bridge, NY 13428 or e-mail: kkelly@leepub.com

APR

**Arkell Center
Events for April**

Arkell Center Programs for ALL AREA Seniors during April are as follows:

Monday-Friday: 11:45 am. The OFA Meals of Montgomery Program serves hot meals, suggested \$3 donation for 60 and older. Call 673-2000 for reservations.

Monday-Friday: 9 am-Noon. Arkell Center's Indoor Walking Program will be open to the local Senior Citizens. Please join us through the winter months.

Tuesdays: 10 am-11 am. Tai Chi Workshop continuing. This 6 week workshop is sponsored by St. Mary's Healthcare, free of charge to all seniors who wish to participate. Next workshop begins on the 17th.

Mon., Wed. & Fri.: 10-10:30 am. Senior Exercise Program is in the basement. Open to all area Seniors. Coffee after.

Wednesdays: 2:30-3:30 pm. Gentle Yoga with instructor Patty Pietrowicz in the basement. Open to all Area Seniors. \$5 donation.

SPECIAL EVENTS

COMING JUNE 16. Canajoharie Sr. Cit. Club trip to McCadden Theatre. "NICE WORK IF YOU CAN GET IT". Cost \$47 members, \$52 non-members. Call 673-5588.
Apr. 20, 27: 12:30 pm-4 pm. Senior Citizens Pinochle Card Party, donation \$2, prizes & refreshments. If you would like to sub, call Terry at 673-5635.
Apr. 22: 11:30 am. Join

us for a joint luncheon with Arkell Hall residents. OFA meal is sweet & sour pork, rice, broccoli, wheat bread & pears. Gary Van Slyke performing Bird Songs at 12:30 pm.

Apr. 26: 11:15 am-12:15 pm. Blood Pressure Clinic. Home Health Care Partner's Corp. (Co-Sponsored by St. Mary's & Nathan Littauer Hospital). Home Health Care Partners Corp. also provides health and wellness information.

Apr. 28: 9:30 am. Join us for Breakfast with our Seniors. Bring a friend & a dish to share.

Apr. 28: 1 pm. Arkell Center, Water Color Class with instructor Joanne Resch. \$10 fee includes all supplies needed to complete a picture the same day. Call 673-4408.

Apr. 29: 1:30 pm. Mr. Hubbard of The Friends of Ulysses S. Grant Cottage presents "Secret

Calendar 20

47th Annual Mohawk Valley Machinery Consignment Sale

Sat. April 30, 2016 • 9:30 AM
Corner of NY 163 and Clinton Rd., Fort Plain
See Auctionzip.com #35160
Armitstead Auctions
518-993-2290

**2 Day Annual Spring
Consignment Benefit Auction!!**

**OUR HUGE SPRING FLOWER AUCTION
AT THE PRODUCE AUCTION**

840 FORDSBUSH RD., FORT PLAIN
Friday Afternoon, May 6th 4:30 to 8:00pm
Saturday, May 7th 8:30am

Carriages, Buggies, Sleighs, Lawn and Garden, Tools,
Hand Tools, Chain Saws, Woodworking Tools,
Trees, Flowers, Shrubs, Hanging Baskets,
Furniture, Crafts, Food, Groceries, and
hundreds of other items will be here to sell.

CHICKEN BBQ, CHICKEN DINNERS, HOMEMADE PIZZA,
FISH SANDWICHES, ROOT BEER FLOATS AND MORE WILL
BE AVAILABLE ON FRIDAY STARTING AT 3:00PM
PANCAKE BREAKFAST ON SATURDAY MORNING
STARTING AT 7:00AM. FOOD WILL BE BY AMISH LADIES.
LARGE SELECTION OF HOME COOKED FOOD ALL DAY!
ALL PROFITS AND PROCEEDS TO BENEFIT AMISH
HOSPITAL AND MEDICAL BILLS. FOR DETAILS AND
CONSIGNMENTS CONTACT BEN KING 518-568-5684 OR
JR AT 518-993-4668 AND FOR HEIFER CONSIGNMENTS
CONTACT ALVIN STOLTZFUS 518-993-9926

OUR NEW LOCATION!!

JR's Auction

7403 St Hwy 5 • St. Johnsville, NY 13452 • (518) 993-4668
(Formerly Springers)

ANTIQUE CONSIGNMENT AUCTION Every Tuesday at 5:00pm

ATTENTION we have found a new supplier for Lumber and Building Materials!! Stop in every Tuesday night to see what we have for over Auction!!! Already consigned is 1-nice Maple China Cabinet, Maple Bookcase, 1-Metal 4 door locker, 2-nice wood shop shelf nits, 4-antique tool cabinets and much more!! Your Consignments Wanted!!

Sportsman and Tool Consignment Auction

WEDNESDAY APRIL 13TH 6:00PM

We are looking for nice Taxidermy and Ammunition Consignments for this Auction!! also Black Powder Rifles, Sporting Goods, New Tools, Used Tools, Tack, Lead Ropes, Snaps, and more!! will also take consignments for boats, canoes, campers, 4 wheelers, trailers & more. No Guns that require a back ground check!!

We are now getting our own FFL License should be ready for this fall will still be having our regular Sporting Auction with ammunition and tools. Don't Miss it!!

St Johnsville Fire Company Benefit Auction

SATURDAY APRIL 16TH 10:00AM

Donations Wanted; proceeds will raise money for the Fireworks and expenses for the Fire Company!! Help Us Raise Money!! Support The Community!! Donations Wanted of: Antiques, Furniture, Household, Tools, Equipment, Outside Items, New Tools, Machinery and more.

4th Annual Spring Consignment Auction

SATURDAY APRIL 23RD 9:00AM 3 AUCTIONEERS WILL BE SELLING!!

Farm Machinery, Equipment, Tools, Antique Buggies, Antique Machinery, Sleighs, Small Animals, Flowers, Trees, Shrubs, Furniture, and much more!!

Inside Main Hall: Furniture, and Antiques! Under Tent: New Tools and Tack!!
Pole Barn: Small Animals! Outside in Lean-to: Trees, Shrubs, Flowers!!

ALREADY CONSIGNED; 1-CIDER PRESS WITH GRINDER, 1-1933 CLECTRAC MINI DOZER W/BLADE (WORKS)
2 SLEIGHS, 2 BUGGIES, 1- RARE ANTIQUE WICKER PONY CART, 1-BUCKBOARD WAGON,
3-ANTIQU FANNING MILLS, 2-WALK BEHIND PLOWS, 1-3 POINT FERTILIZER SPREADER,
1-275 GALLON FUEL TANK, 2 WORK HORSE HARNESSSES, A LARGE LOAD OF TREES, SHRUBS,
AND PERENNIALS FROM LANCASTER COUNTY!! AND

MORE STILL COMING!! THIS IS THE THE AUCTION TO TURN YOUR ITEMS INTO CASH!!

We are taking consignments for this Auction including; Farm Machinery, Equipment, Tractors, Bull Dozers, Lawn Tractors, Hay Equipment, Trailers, Boats, Canoes, Outdoor Sporting Equipment, 4 Wheeler's, Lawn and Garden Equipment!! Inside Consignments we need Complete Estates, Antiques, Furniture, Paintings, Collectibles, New and Used Furniture!! We are also receiving consignments for Flowers, Trees, Shrubs, and Garden Related Items!! Chicken BBQ, Subs, Ice Cream, and lots of good homemade food!!!!

HUGE ESTATE SALE

39 Locust Ave., Amsterdam, NY 12010

Fri., April 15th-10am 6 pm & Sat. April 16th-10am-3pm

Antique white porcelain Glenwood gas & coal burning stove, cherry fireplace mantle, 2 mint condition walnut cedar chests, maple 4 poster queen size bedroom set complete, mahogany drop leaf dining room table, Victorian stand, French Provincial full size bedroom set, birds eye maple chest of drawers, electric lift chair, 2 sofas, maple hutch, Fostoria Fiestaware, china, chrystal, books, records, tons of linens, antique surveying transit set, brick layers stone mason tool set, power tools, assortment of old & new hand tools. **3 floors of wonderful treasures for everyone!**

Looking forward to seeing you all. Follow the Hot Pink Signs
Questions 518-725-0922

KING'S

Sat., April 16th - Consignment Auction ~ 6:33pm

Sat., April 23rd - Consignment Auction ~ 6:33pm

Sun., April 24th - Breeder Auction ~ 11:33am

Sat., April 30th - Consignment Auction ~ 6:33pm

Burrows Rd., West Winfield, NY • **(315) 822-5221**
WE ACCEPT CASH - CREDIT CARDS - DEBIT CARDS

WEEKLY SALES EVERY MONDAY HOSKING SALES

Weekly Sales Every Monday 11:30 AM with Misc. & Small Animals, 1:00 PM Dairy, followed by feeders, sheep, lamb, goats, pigs. Calves start at 5:00 PM followed by cull beef. Call for more info and note all times are approximate. Our volume is increasing weekly - join your neighbors & send your livestock our way!

***ATTENTION ORGANIC PRODUCERS -
WE ARE NOW A CERTIFIED ORGANIC MARKETING AGENCY***
IF YOU HAVE ANY QUESTIONS PLEASE CONTACT US.

Monday, April 4th - Sold 180 Head. Cull ave. \$.68 Top Cow \$.95, Bulls/Steers \$.88, Bull calves top \$3.35, heifer calves top \$3.45, Dairy feeders \$.92 - \$.96, Feeder bulls \$1.00, Feeder Heifers \$1.21 - \$1.23, Goats up to \$235, Kid goats up to \$90.

Mon. April 18th - Normal Monday - This will be our Spring Fat Cow & Feeder Turnout Sale. Special group of 400# - 500# Angus feeders. A group of Hereford yrly. Feeders; a load of Angus cross feeders. A lot of calls we expect a good run. We will start excepting cattle on the weekend 4/16 & 4/17. (note we will be doing this during our regular Monday sale) Call to advertise your group

Sat. April 23rd - Annual Spring Machinery & Equipment Auction & we will be selling Plants, Trees, Shrubs, flowers and a load of small hand tools. We will start at 9:30 AM on small and be on large equipment by Noon. The field is filling up a few consignments of: Val-Metal V-Mix 400 w/8' elevator, NH 1410 Discbine (excellent); JD 335 Round Baler, Hayrite transport elevator, NH 256 Rake w/dolley wheel, 16' hay wagon, Ezee trail kicker wagon, 8 1/2x18 Stoltzfus Steel Kicker wagon, 8+2 Stoltzfus Round Bale Wagon, 16' Stoltzfus Feeder wagon w/headlocks, farm dump truck, 3 pt ditch bank mower, NH 310 kicker baler, Onan Diesel Generator 6KW, Ford 1700 Tractor w/snowplow, Farmall A WFE, Bush hog, 2009 16' Corn Pro bumper pull cattle trailer, Kuhn 1219 Manure Spreader, 1209 Haybine, Nickelson Tedder, Ground driven manure spreader. Call to advertise your equipment.

Monday, April 25th - Normal Monday Sale & Monthly Organic Day
Monday, May 2nd - Normal Monday Sale & Monthly Fat Cow & Feeder Sale.

Sat. May 7th - 11:30 AM Georgetown, NY. Many Maples Retirement Registered Brown Swiss Dispersal

Mark your calendars! For these sales:

Sat. Sept. 10th - 10:30AM Homer, NY. Westan Farm Registered Holstein Dispersal. 250 Head of NYS Finest!! Owners: Dan & Bud Weddle.

Sat. Nov. 5th - 11:30AM Fall Premier All-Breed Sale
Sat. March 25th - 2017 Spring Premier All-Breed Sale

**LOOKING TO HAVE A FARM SALE OR JUST SELL A FEW -
GIVE US A CALL.**

**Trucking Assistance - Call the Sale Barn or check out our trucker list on our Website. Call to advertise in any of these sales, it makes a difference. Watch website for any last minute updates.
Directions: Hosking Sales, 6096 NYS Rt. 8, 30 miles South of Utica & 6 miles North of New Berlin, NY.

www.hoskingsales.com Call today with your consignments.
Like us on Facebook

Tom & Brenda Hosking **607-847-6274**

& Family **or 607-847-8800**

6096 St. Hwy. 8, New Berlin, NY 13411 **cell: 607-972-1770 or 1771**



Open House Sunday April 24th, 2-4 PM

(701) Gloversville: 3 BR's 1 1/2 baths. Very well maintained. Interior freshly painted and brand new carpeting throughout. Situated on a quiet one way street near school. 2 car garage. Fenced yard. Only \$89,500

HOME BUYER SEMINAR
Join us to learn more about the home buying process.
Tuesday, April 26, 2016 at 7 pm
First Niagara Bank
6021 State Highway 5
Palatine Bridge, NY

For more information contact: Lisa M Atkins, Mortgage Loan Officer
518-229-1553
Richard Euler, Licensed Real Estate Broker
518-673-3677

Richard Euler
Real Estate
Licensed Real Estate Broker

48 Church Street,
Canajoharie, NY 13317

Real estate... New beginnings

FOR SALE

COUNTRY HOME IN SPROUT BROOK
3 Bedrooms, 2 1/2 Baths, Large Kitchen, Living Room, Dining Room, Den, Laundry Room, Oil Hot Air Heat, Furnace 3 Years Old, 2 Stall Garage.
Asking \$77,000.
518-858-1130

am. Free family fun bike ride. Register at canajohariecyc.org . Call the CYC for more information at 673-5117.

APR 25

"Healing Strong" Natural Healing Support Group

River of Jubilee Church, 5057 Route 5S, Sprakers. 1 pm. This group provides information and encouragement for using natural strategies for health and well-being. This will be our first meeting and meetings will continue on the 4th Mondays. For more information call Jane 518-673-3016.

APR 27

Rabies Clinic

Dolgeville Fire Department, 20 S. Helmer Ave., Dolgeville. 5:30-7 pm. Pre-register at www.herkimercounty.org . A \$5 donation per pet is suggested to defray costs.

Learn to Meditate

The Arkell Museum, 2 Erie Boulevard, Canajoharie. Wednesdays 5:30-6:30 pm through June 15. Free. Beginner and experienced meditators welcome. Visit www.meditateupstate.com , call 518-428-4692 or email melaniep@meditateupstate.com .

MAY 7

The Ames Museum

Ames, NY. 9 am-3 pm. Visit our website at www.amesmuseum.weebly.com . Vendors needed for Sept. 17 summer's end celebration. Space is free. For more information call 518-673-5820.

Chicken Bar-B-Que

Stratford United Methodist Church, 1511 State Route 29A, Stratford. 3:30 pm. Dining room and take-outs. Adult \$9, Child \$4. Chicken, scalloped potatoes, rolls, beans/mushroom sauce, applesauce, pie. For more information call 429-7058.

MAY 30

Opening Day, Fort Klock

St. Johnsville. 10 am-4 pm
Calendar 21

Calendar of events

Calendar from 19

Agents in Hoop Skirts." Bring a friend, refreshments will be served.

MEETINGS
Apr. 21 & 28: 10:15 am-11 am. The Diet Club meets in the Gallery at Arkell Ctr. The goal is to be accountable while losing or maintaining your weight. Call 673-2112.
Apr. 26: 10-11 am. Alzheimers Caregiver Support Group. Please join us.
Apr. 29: 1pm. Canajoharie Senior Citizens Club Meeting.

State Highway 5, Nelliston. Apr. 15, 7 pm. Youth Group Night. Everyone over age 9 is welcome. 8 pm. Presentation "In the Image of God or In the Image of an Animal?"
Apr. 16, 10 am. Presentation "The Four Ds of Dinosaurs!" and "The Kids' Dinosaur Carnival" - for kids up to 6th grade. (includes 15 dinosaur games). 6 pm. Fellowship dinner—all are welcome (bring a dish to share).
7 pm. Presentation "Prove It: The Tower of Babel, Ancient Advanced Technology, and Aliens(?)"
Apr. 17, 9:15 am. Sunday School for ALL ages. Presentation "Design that Could NOT have Evolved!" 10:30 am. Worship Service Message "Prove It Really Happened: Sodom and Gomorra, Jericho, and David & Goliath!" For more information call 993-3458.

APR

Kindergarten Enrollment

Cherry Valley Central School. For questions related to Kindergarten enrollment for 2016-17 school year, contact Mrs. Carson in the District Office at 607-264-9332 ext. 501. Your child must turn 5 years old on or before Dec. 1, 2016 in order to be eligible to enroll in Kindergarten.

APR

Prekindergarten Registration

Cherry Valley Central School. If your child is going to be 4 years old on or before December 1st, 2016, he or she is eligible to apply for our Prekindergarten program. Applications will be available in the District Office on April 4, 2016. Contact Mrs. Carson for more information at 607-264-3265 ext. 501 or email lcarson@cvschools.org .

APR 15 - 17

Paul Veit, "The Dino Pastor"
Valley Alliance Church,

APR 16

Rabies Vaccination Clinic

Palatine Town Barn, 817 Stone Arabia Rd., Fort Plain. 9-11 am. Veterinarian administration fee is \$10 per rabies vaccine. Other vaccines will be available at an additional fee. For more information about rabies contact Montgomery County Public Health at 853-3531 Monday-Friday 8:30 am-4 pm or your veterinarian.

APR 23

Ride with Stewart's Shops
Fort Plain Stewart's. 8:45

MOHAWK Towne & Country Realty
Sue Leavitt, Licensed Real Estate Broker
Corner Rte. 5 & McKinley Rd., Palatine Bridge, NY • 518-673-5482

Country Home 24 acres
Old Sprakers Rd, Canajoharie. Private 3 BR has hardwood floors, original woodwork, Living, Dining, Den, New Bath, huge attic (where owners started remodeling into BR & Bath) good roof, drilled well, BOTH Oil & new Wood furnace plus a nice big yard & a new Outldg for storage, Well worth a look. **Asking \$129,900.**

3 Bedroom Home w/Apt.
Excellent Ft. Plain Home with Apartment & 5 Stall Garage for rentable income. Owner's side has built in Dining Hutch, Den, Livingroom, & Bath. **Asking \$79,900**

St. Johnsville 4 Family
in good condition. Hardwood floors, French doors, updated electric, steel roof, Lg. apts - 3,2,2,1 Bedrooms; full Baths, Living room; Kitchens with appliances. new sewer pipes, tenant parking. **Asking \$105,500**

2 Family Money Maker ONLY \$35,000
Gloversville. In VERY GOOD condition. Good income, fully remodeled & repaired Kitchen, Living room, Bedroom & Bath each apartment; or can live in one & let the rental help pay your mortgage. Either way—a darn good investment.

2.80 Acres Canajoharie Schools
Looking for a "spot to build"? Nice level piece with some woods (inc. Norwegian Spruce & Scotch Pines) .350" frontage, dug well, and electric at the road. **Asking \$10,400**

3+ Acres to build Reduced to \$9,800
Privacy & Views, Cherry Valley Schools; level land affordable taxes, property is undeveloped, with electric at the road; & 200 ft. road frontage Southern Exposure on Rte 163. Ft Plain... **Offers?**

Amanda Haig, Sales Assoc. 518-673-3235
Art Meka, Sales Assoc. 518-673-5401
Carol Meka, Assoc. Broker 518-673-5401
Michaela Germond, Sales Assoc. 315-219-1510

Visit Us: www.mohawk-realty.com

Automotive

Calendar of events

Calendar from 20

pm. Call 518-568-7779 for more information or visit www.fortklockrestoration.org.

JUN 4

The Ames Museum
Ames, NY. 9 am-3 pm. Visit our website at www.amesmuseum.weebly.com. Vendors needed for Sept. 17 summer's end celebration. Space is free. For more information call 518-673-5820.

JUN 9 - 12

The Fort Plain Museum's Second Annual Conference

The American Revolution. Bigger than last year. More Authors, Historians, stories and two bus tours. Conference \$50, Banquet \$50, Bus Tour \$35 each. For registration form or for more information call Brian Mack at 518-774-5669 or email fortplainmuseum@yahoo.com.

JUN 11 - 12

Hammer In
Fort Klock, St. Johnsville. 10 am-4 pm. All blacksmiths are invited to attend and demonstrate how iron items were created in early times. Call 518-568-7779 for more information or visit www.fortklockrestoration.org.

JUL 4

Independence Day
Fort Klock, St. Johnsville. 12-4 pm. At 1 pm an old fashioned salute to showcase American History as the Declaration of Independence is read. The Second Tryon County Militia salute will follow to honor those who fought for freedom. Strawberry festival. Bake sale. Call 518-568-7779 for more information or visit www.fortklockrestoration.org.

JUL 9

The Ames Museum
Ames, NY. 9 am-3 pm. Visit our website at www.amesmuseum.weebly.com. Vendors needed for Sept. 17 summer's end celebration. Space is free. For more information call 518-673-5820.

JUL 9 - 10

2016 Canal Days
Visitor Center in Fort Hunter, NY. This annual event is a fun mix of games, food, music, education, recreation, a car show and more. For more information contact Janice at 518-829-7516 or email Schoharie.Crossing@parks.ny.gov.

JUL 24

Stone Soup Concert
Fort Klock, St. Johnsville. 7 pm in the Dutch barn. Call 518-568-7779 for more information or visit www.fortklockrestoration.org.

AUG 2, 3 & 4

Young Pioneer Program
Fort Klock, St. Johnsville. 9 am-3:30 pm. All children between the ages of 9-13 are invited to attend this educational program. Children will experience frontier life and colonial lifestyles through educational hands on activities while have loads of fun! Call Fort Klock at 518-568-7779 to enroll. A small fee is charged, reserve your early, limited registration.

AUG 20

The Ames Museum
Ames, NY. 9 am-3 pm. Visit our website at www.amesmuseum.weebly.com. Vendors needed for Sept. 17 summer's end celebration. Space is free. For more information call 518-673-5820.

SEP 1

Rabies Clinic
Salisbury Fire Department, 2549 St. Rt. 29, Salisbury Center. 5:30-7 pm. Pre-register at www.herkimercounty.org. A \$5 donation per pet is suggested to defray costs.

SEP 10 - 11

Craft Fair
Fort Klock, St. Johnsville.
• Saturday, 10 am-5 pm.
• Sunday, 10 am-4 pm.
Call 518-568-7779 for more information or visit www.fortklockrestoration.org.

Joe Sekel's Automotive LLC

Sales & Service

2005 Chevy Silverado 4x4, 4 Dr.	2004 Dodge Durango 2000 Dodge Ram 1500 4x4
2004 Dodge Ram 2500 4x4, 4 Dr., 8ft. Box	1998 Dodge 1500 4x4 w/Plow

(315) 823-3182

1051 Bellinger Road • Fort Plain, NY 13339

SEP 17

The Ames Museum Summer's End Celebration

Ames, NY. 9 am-3 pm. Visit our website at www.amesmuseum.weebly.com. For more information call 518-673-5820.

OCT 15

The Ames Museum

Ames, NY. 9 am-3 pm. Visit our website at www.amesmuseum.weebly.com. For more information call 518-673-5820.

NOV 5

The Ames Museum

Ames, NY. 9 am-3 pm. Visit our website at www.amesmuseum.weebly.com. For more information call 518-673-5820.

DEC 4

Saint Nicholas Day

Fort Klock, St. Johnsville. A traditional holiday custom that dates from the fourth century. The celebration is from a rich heritage that is preserved through colonial music, homemade cookies and gingerbread, hot chocolate and spiced cider. All children receive a homemade wooden ornament from St. Nicholas. In addition, the Tryon County militia will drill, there is a storyteller, roaring fires, pine bough decorations and tree. Call 518-568-7779 for more information or visit www.fortklockrestoration.org.

DEC 7

Village of Ames Tree Lighting at the Museum

Ames, NY. 6:30-7 pm. Refreshments to follow at the Ames Fire Department.

THIS WEEK'S SPECIAL!!

2008 DODGE RAM 1500 QUAD CAB SLT 4X4



Silver,
Only 64,000 Miles!! V-8
Auto, AC, CD, Alloys,
Trailer Tow, Power Seat,
Big Horn Edition,
Extra Nice!!!

SALE: \$18,995

John C. Miller, Inc.

509 NORTH PERRY ST., JOHNSTOWN • 518-762-7124



View Our Entire Inventory Online At:
www.johncmiller.com

CARS WANTED DEAD OR ALIVE!
(PICK UP AVAILABLE)
WE PAY YOU \$\$\$
CALL 315-794-5498

NEW YORK AUTOMOTIVE REPAIR
518.568.CARS • 518.568.2277
Now Open Saturday & Sunday 9am - 3pm
Hours: Mon-Fri. 8am-5pm • Sat. & Sun. 9am-3pm
58 East Main St., St. Johnsville, NY 13452

Automotive

Four ways to make your vehicle more eco-friendly

Many new vehicles are made with the environment in mind, as more and more drivers are embracing eco-friendly features that reduce the carbon footprints of their vehicles. But motorists need not purchase new cars to make their driving

habits more environmentally friendly. The following are a handful of steps drivers can take to protect the environment regardless of how new or old their vehicles are.

1. Maintain your vehicle.

Even if your car or

truck has no eco-friendly features designed to reduce fuel consumption and cut down on emissions, that does not mean the vehicle cannot be more fuel-efficient or produce fewer emissions. Adhering to the maintenance schedule recom-

mended in your vehicle owner's manual can conserve fuel and cut back on potentially harmful emissions. Well-maintained vehicles burn less fuel, as they don't force engines and other components to work as hard during operation as vehi-

cles that have not been taken care of. Replace worn down or dirty spark plugs, which misfire and waste fuel, and fuel and air filters once they are no longer operating at peak capacity. Address any issues that arise with your vehicle's emissions systems immediately, visiting your mechanic if the vehicle seems to be sputtering or emitting any abnormal fumes.

2. Slow down.

Driving above the speed limit is not just dangerous but potentially harmful to the environment as well. According to the United States Department of Energy, each five miles per hour drivers drive over 50 miles per hour is akin to adding an additional \$0.14 per gallon for gas. That's because driving above 50 miles per hour is far less fuel-efficient than driving below that figure. So slowing down when posted speed limits mandate driving 50 miles per hour or slower is not just safer and more eco-friendly, it's better for your wallet as well.

3. Keep cargo off the roof.

When you must haul

cargo, keep that cargo in rear-mount cargo boxes or the backseat or trunk of your car rather than the roof. Rooftop cargo boxes make vehicles less aerodynamic, reducing highway fuel economy by as much as 17 percent according to the U.S. DOE. By comparison, rear-mount cargo boxes reduce highway fuel economy by just 2 to 5 percent. If you haul cargo in your trunk, remove items when your trip is complete, as excess, unnecessary weight in the car will reduce its fuel efficiency.

4. Inspect the gas cap.

Few drivers may think to examine their gas caps while filling up at the pump, but such an inspection may reveal cracks or other damage that are wasting fuel. When gas caps are cracked, loose or damaged, fuel can escape gas tanks as a vapor, wasting fuel and contributing to emissions. If the cap is in need of replacement, consult your mechanic, the dealer who sold you your vehicle or the vehicle manufacturer.

THE BEST FOR LESS... HASSLE FREE!

New Year... New Deals

JESSE LICARI

HASSLE FREE



2015 SUBARU WRX STI
CPO \$2,000 below NADA book
1 Owner * Navigation * 26k *
Premium Sound \$34,475



2012 DODGE CHARGER R/T
Red Leather Interior * Heated
Seats * Navigation * 45k
\$22,995



2011 DODGE AVENGER LUX
Leather * Sunroof * Touch Screen
\$12,995



2011 DODGE GRAND CARAVAN SXT
29K * DVD Player
* Stow-N-Go * Navigation
\$22,595



2014 DODGE JOURNEY SXT
CPO \$2,000 below NADA Book
Value * 45k * Third Row * AWD
\$19,495

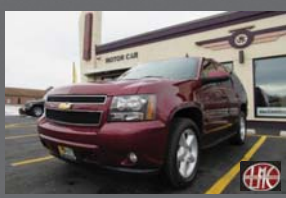

2008 CHEVROLET TAHOE LT
LT Pkg * Third Row * 4WD
* Sunroof
\$18,995



2011 FORD F150 SXT
4WD * 31k * V8! 5.0L
* Lots of Xtras!
\$23,995



2012 DODGE RAM 1500 ST
4WD * 54k * Front Line Ready
\$23,795

ROUGH COUNTRY
SUSPENSION SYSTEMS
CNY's Authorized Dealer

FRESH Start
AUTO LOAN PROGRAM
EVERYONE'S APPROVED!

EVERY CAR WE SELL
GWC WARRANTY
CERTIFIED
PRE-OWNED VEHICLES
DAY ONE/MILE ONE COVERAGE

Quality collision repair since 1949

Midway
Body Shop

Quality collision repair since 1949



Owner Mike Fredericks offers full collision repair including frame straightening and glass replacements. Midway Body Shop is the first body shop to use **Envirobase® HP Waterborne Refinish System**. Since 2003 Midway has also used **SPEEDLINER®** spray-in bed liner.



6152 State Highway 5 • Palatine Bridge, NY 13428
P: (518) 993-2215 • C: (518) 229-8595

www.Midway-BodyShop.com

LICARIMOTORCAR.COM | 315.866.4141

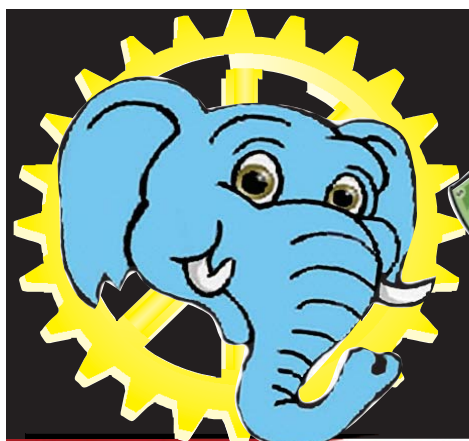

JUMBO LOT

We're Here for YOU!!!

Mon.-Fri. 9am-6pm;
Saturday 10am-4pm

Find us on Facebook



518.993.8140

518.613.4127

88 East Main St. Nelliston, NY

www.route30jumbolot.com

We're Gearing Up For Tax Time

Come To Jumbo Lot THE LOT OF OPPORTUNITY

NEW VEHICLES DELIVERED WEEKLY!

★ MUST SELL ★



GREAT SUV
2008 Jeep Compass AWD
81k Miles
\$9,995 \$8,975



Great for the Whole Family
2010 Dodge Grand Caravan SE
87k Miles
\$10,995 \$9,995



Navigation System
2008 Honda Civic EX-L w/Nav
89k Miles
\$9,995 \$8,995



Excellent Condition
2011 Chevy HHR LT
84k Miles
\$9,995 \$8,995



Luxury At It's Best!
2007 Buick Lacrosse CX
119k Miles **\$6,775**



Fun Car Great MPG

2009 Chevy Cobalt LT
79k Miles **\$7,450**



NICE 4 DOOR

2009 Chevy Impala LS
93k Miles **\$7,925**



FUN RIDE!

2009 Kia Rondo LX
76k Miles **\$7,980**



Beautiful Luxury Car

2008 Mercury Milan
80k Miles **\$7,995**



POWER EVERYTHING, LEATHER & MOONROOF

2008 VW Jetta
77k Miles **\$7,995**



Excellent MPG

2014 Mitsubishi Mirage
62k Miles **\$8,990**



Roof, Power Everything

2007 Ford Mustang
85k Miles **\$8,995**



40+ MPG

2012 Hyundai Accent GLS
74k Miles **\$9,550**



Great SUV

2007 Hyundai Santa Fe
90k Miles **\$9,650**



4WD

2008 Jeep Patriot Sport
89k Miles **\$9,995**



Pony Package 5 spd

2008 Ford Mustang
80k Miles
\$10,825



AWD

2008 Ford Edge
92k Miles **\$10,995**
NADA \$11,750



High Output Engine!

2010 Dodge Charger SXT
82k Miles **\$12,995**



Hemi 4x4

2007 Dodge Ram
93k Miles **\$14,495**



Great 4x4

2009 GMC Sierra 1500 Ext Cab
102k Miles **\$14,995**
NADA \$17,950

Use Your Refund To Add Some Value To Your Life

WE NEVER SAY NO!!

If You've Had A Repossession

We Can Still Get You A Bank Loan!

Service Contracts

Available on ALL Vehicles

All Vehicles Priced to Sell Below NADA... (National Automobile Dealers Association)

50+ Vehicles Don't Just Pass Us By, Give Us A Try! You don't need to go to the HUGE dealers to get a quality car. Support your local small town dealer!

- ★ WEEKLY PAYMENTS ★
- ★ CHAPTER 13? WE'RE NOT SCARED! ★
- ★ WE NEVER SAY NO! ★
- ★ CAN'T PROVE INCOME? THAT'S OK! ★
- ★ GUARANTEED CREDIT APPROVAL ★
- ★ UNEMPLOYMENT BENEFITS? NO PROBLEM! ★

OVER 30 QUALITY, "PRICED-TO-SELL" VEHICLES AVAILABLE! SOMETHING FOR EVERYONE!

REGISTERED FULL SERVICE REPAIR SHOP

*Tax & DMV not included. Dealership not responsible for advertised misprints.

Carol Harper,
Owner/Proprietor

(518) 993-8140 or (518) 613-4127
route30jumbolot@gmail.com

www.rt30jumbolot.com

QUALITY, DEPENDABILITY AND SAFETY IS OUR MISSION!

FINANCING RATES AS LOW AS 3.99%

*must be credit qualified

Chapter 13 Specialists 100% Approvals 2014-2016





HUGE CAN'T-MISS SAVINGS!



STK# P1451A • 24,296 MILES

2014 FORD FIESTA
\$8,497

PLUS TAXES, TAGS AND DMV FEES!



STK# 6125A • 86,161 MILES

2008 NISSAN ALTIMA
\$8,988

PLUS TAXES, TAGS AND DMV FEES!



STK# R1510 • 46,898 MILES • PRIOR RENTAL

2014 FORD FOCUS
\$9,689

PLUS TAXES, TAGS AND DMV FEES!



STK# 5488B • 57,365 MILES

2012 NISSAN SENTRA
\$9,777

PLUS TAXES, TAGS AND DMV FEES!



STK# R1403A • 45,027 MILES

2012 HYUNDAI® ACCENT
\$9,888

PLUS TAXES, TAGS AND DMV FEES!



STK# 5567A • 65,200 MILES

2009 CHEVY MALIBU
\$10,777

PLUS TAXES, TAGS AND DMV FEES!



STK# 5734B • 32,300 MILES

2013 KIA OPTIMA
\$14,699

PLUS TAXES, TAGS AND DMV FEES!



STK# 4891B • 43,901 MILES

2012 JEEP PATRIOT
\$14,888

PLUS TAXES, TAGS AND DMV FEES!



STK# 6297A • 28,326 MILES

2013 DODGE GRAND CARAVAN
\$16,995

PLUS TAXES, TAGS AND DMV FEES!



STK# 6070A • 46,166 MILES

2011 FORD F-150
\$24,991

PLUS TAXES, TAGS AND DMV FEES!



STK# 5669A • 46,810 MILES

2012 FORD F-150
\$26,288

PLUS TAXES, TAGS AND DMV FEES!



STK# P1456 • 49,722 MILES

2013 FORD EXPLORER
\$28,888

PLUS TAXES, TAGS AND DMV FEES!



STK# 6038A • 5,348 MILES

2015 RAM 1500
\$29,555

PLUS TAXES, TAGS AND DMV FEES!



STK# 6135A • 48,901 MILES

2012 FORD F-150
\$29,777

PLUS TAXES, TAGS AND DMV FEES!



STK# P1533 • 44,602 MILES

2011 FORD F-150
\$29,891

PLUS TAXES, TAGS AND DMV FEES!



STK# P1534 • 24,635 MILES

2013 FORD F-150
\$29,991

PLUS TAXES, TAGS AND DMV FEES!



STK# 6002A • 34,189 MILES

2014 FORD F-150
\$30,488

PLUS TAXES, TAGS AND DMV FEES!



STK# 6014A • 8,881 MILES

2014 FORD F-150
\$31,555

PLUS TAXES, TAGS AND DMV FEES!



STK# 6078A • 14,937 MILES

2008 FORD F-250SD
\$32,899

PLUS TAXES, TAGS AND DMV FEES!



STK# 6006A • 6,439 MILES

2015 GMC SIERRA 1500
\$38,888

PLUS TAXES, TAGS AND DMV FEES!

**NEED FINANCING? BILLY MAY BE ABLE TO HELP.
APPLY FOR PRE-APPROVAL AT: GETHUGEcredit.com**



FUCCILLO FORD OF NELLISTON



6500 NY-5 • FORT PLAIN, NY 13339 • 888-655-9420 • HUGEPLEX.COM HOURS: SALES MON.-THURS. 9-7, FRI.-SAT. 8-6, SUN. 10-5 SERVICE MON.-FRI. 9-5
PRIOR SALES EXCLUDED. SEE DEALER FOR COMPLETE DETAILS. PRICING AVAILABLE THROUGH APRIL 30, 2016.